



Original Notice

© 2018 Robotic Inc.

Robotiq FT 300 Force Torque Sensor



Instruction Manual

LEAN   
ROBOTICS  
[robotiq.com](http://robotiq.com) | [leanrobotics.org](http://leanrobotics.org)



<b>1. General Presentation</b> .....	<b>9</b>
<b>1.1. Main features</b> .....	<b>10</b>
1.1.1. FT 300 Force Torque Sensor .....	10
1.1.2. Force Copilot .....	12
<b>2. Safety</b> .....	<b>13</b>
<b>2.1. Warning</b> .....	<b>14</b>
<b>2.2. Intended Use</b> .....	<b>15</b>
<b>3. Installation</b> .....	<b>16</b>
<b>3.1. Scope of Delivery</b> .....	<b>16</b>
3.1.1. Options .....	16
<b>3.2. Environmental and Operating Conditions</b> .....	<b>17</b>
<b>3.3. Mechanical Connections</b> .....	<b>17</b>
<b>3.4. Power Supply Specifications</b> .....	<b>19</b>
<b>3.5. Wiring</b> .....	<b>20</b>
3.5.1. Wiring with USB to RS485 Converter .....	21
3.5.2. Wiring with RS232 to RS485 Converter .....	22
<b>3.6. Installation for Universal Robots</b> .....	<b>23</b>
3.6.1. Force Copilot URCap Package .....	24
Installation .....	24
Calibration Procedure .....	28
Calibration Procedure with Universal Robots .....	29
Calibration Procedure for the Visual Demo Software (PC) .....	33
Payload/CoG .....	34
ActiveDrive Toolbar Installation .....	35
Firmware upgrade .....	36
Uninstalling the URCap Package .....	37
License Agreement .....	38
3.6.2. UR Package without URCaps .....	42
Driver Package Installation .....	42
Calibration .....	42
Testing the software package .....	43
Removing the Package .....	43



<b>3.7. Status LED</b> .....	<b>44</b>
<b>4. Software</b> .....	<b>45</b>
<b>4.1. Control with Universal Robots</b> .....	<b>46</b>
4.1.1. ActiveDrive Toolbar .....	47
Overview .....	47
Toolbar collapsed .....	47
Toolbar expanded .....	47
ActiveDrive modes expanded .....	47
Features .....	48
Error Messages Overview .....	50
4.1.2. Using the force and torque values .....	52
4.1.3. Path Recording .....	54
Overview .....	55
Features* .....	57
4.1.4. Insertion nodes .....	58
Child nodes .....	59
Features (Spiral) .....	60
Features (Rotational) .....	61
Features (Linear) .....	62
4.1.5. Find Surface node .....	63
4.1.6. Using the Force Torque Sensor's Data in Force Nodes .....	66
4.1.7. Force Control Node .....	66
Overview .....	66
Features .....	68
Reference frame .....	68
Parameters .....	69
Test .....	72
4.1.8. Multipoint Path Node .....	73
How to set up a Multipoint Path .....	74
Step 1 .....	74
Step 2 .....	75
<b>4.2. Development Package</b> .....	<b>77</b>
4.2.1. Distribution License .....	77



4.2.2. Linux .....	79
Package Files – Description .....	79
Procedure to Compile and Test the Provided Source Code .....	79
Adapt to a User Application .....	80
4.2.3. Windows .....	81
Package Files – Description .....	81
Procedure to Compile and Test the Provided Source Code .....	81
Adapt to a User Application .....	82
<b>4.3. Visual Demo Software .....</b>	<b>83</b>
4.3.1. Software Package Installation .....	83
<b>4.4. Serial Communication .....</b>	<b>85</b>
4.4.1. Modbus RTU .....	85
Connection Setup .....	86
Read Holding Register (FC03) .....	88
4.4.2. Data Stream .....	89
Preset Multiple Registers (FC16) .....	89
<hr/>	
<b>5. Specifications .....</b>	<b>91</b>
<b>5.1. Technical Dimensions .....</b>	<b>91</b>
5.1.1. Tool Side Bolt Pattern .....	92
<b>5.2. Mechanical Specifications .....</b>	<b>93</b>
5.2.1. Moment of Inertia and Center of Mass .....	94
5.2.2. Overload Capacity .....	95
<b>5.3. Signal Specifications .....</b>	<b>96</b>
<b>5.4. Electrical Ratings .....</b>	<b>98</b>
<b>5.5. Couplings .....</b>	<b>99</b>
5.5.1. Blank Coupling .....	100
<hr/>	
<b>6. Maintenance .....</b>	<b>101</b>
6.1. Maintenance Intervals .....	101
<hr/>	
<b>7. Spare Parts, Kits and Accessories .....</b>	<b>102</b>
<hr/>	
<b>8. Troubleshooting .....</b>	<b>103</b>
<b>8.1. General troubleshooting .....</b>	<b>103</b>
8.1.1. An offset has appeared in the Sensor data .....	103



---

8.1.2. Procedure to determine if the Sensor is functional .....	103
<b>8.2. Troubleshooting on Universal Robots .....</b>	<b>104</b>
8.2.1. ActiveDrive Toolbar troubleshooting – Error messages overview .....	104
8.2.2. Monitoring the Sensor state .....	105
<b>8.3. Troubleshooting on other platforms .....</b>	<b>107</b>
8.3.1. USB converter detected as a mouse by Windows .....	107
8.3.2. Data frequency under 100 Hz in Windows .....	107
8.3.3. In Linux, the serial port cannot be opened .....	107
<hr/>	
<b>9. Warranty .....</b>	<b>109</b>
9.1. Exclusions .....	110
<hr/>	
<b>10. Contact .....</b>	<b>111</b>
Appendix A – Translation of Original EC Declaration of Incorporation .....	113
Appendix B – Applied Standards .....	114



# Revisions

---

Robotiq may modify this product without notice, when necessary, due to product improvements, modifications or changes in specifications. If such modification is made, the manual will also be revised, see revision information. See the latest version of this manual online at: [support.robotiq.com](http://support.robotiq.com).

## Revision 2018/10/09

Major update: all reference to the software compatible with UR (URCap) have been renamed Force Copilot  
Updated Software section to include the Multipoint Path node and rename the FT Mode node to Force Control node

## Revision 2018/06/18

Updated Software (subsections 4.1.2 and 4.1.5) to include Robotiq FT Mode node and corresponding script functions

## Revision 2018/03/26

Removed all references to FT 150 Force Torque Sensor

## Revision 2018/02/13

Removed reference to ROS package (section 4.3)

## Revision 2017/12/11

Updated control with Universal Robots (section 4.1 and subsections)

## Revision 2017/10/30

Updated mechanical specifications (section 5.2)

Updated signal specifications (section 5.3)

## Revision 2016/11/18

Updated FT 150 signal specifications (section 5.3)

Updated installation for Universal Robots (section 3.8 and sub sections)

Updated Control with Universal Robots (section 4.1 and sub sections)

## Revision 2016/04/26

Update for ActiveDrive toolbar, added calibration instructions

## Revision 2016/01/18

Update for FT 300

## Revision 2014/09/08

Official release



## Copyright

© 2016, 2018 Robotiq Inc. All rights reserved.

This manual and the product it describes are protected by the Copyright Act of Canada, by laws of other countries, and by international treaties, and therefore may not be reproduced in whole or in part, whether for sale or not, without prior written consent from Robotiq. Under copyright law, copying includes translation into another language or format.

Information provided by Robotiq in this document is believed to be accurate and reliable. However, no responsibility is assumed by Robotiq for its use. There may be some differences between the manual and the product if the product has been modified after the edition date.

The information contained in this document is subject to change without notice.





# 1. General Presentation

The terms "Sensor", "Robotiq Sensor", "Force Sensor", "Torque Sensor", "FT 300 Force Torque Sensor" used in the following manual refer to the Robotiq Force Torque Sensor FT 300 unless specified. The Robotiq FT 300 Force Torque Sensor is a robotic peripheral designed for force and torque data acquisition.

The term "Force Copilot" used in the following manual refer to the Robotiq Force Copilot unless otherwise specified. The Robotiq Force Copilot is a software package designed for using the force and torque values read by a force torque sensor in the framework of robotic applications. The software interface provides force and torque feedback that can be used for robot hand guiding, force control processes, assembly tasks, product testing, etc.

## Info

The following manual uses the metric system, unless specified, all dimensions are in millimeters.

## Info

The following section presents the key features of the Sensor and must not be considered as being related to Sensor operation, each feature is detailed in the appropriate section of the manual. Safety guidelines must be read and understood before any operation is attempted with the Sensor.

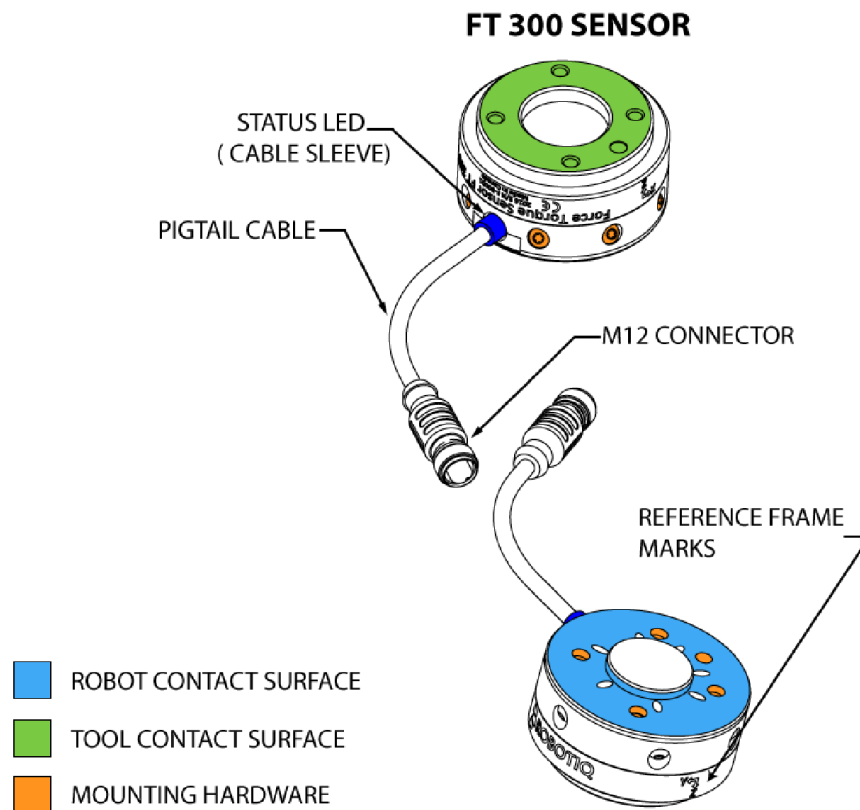

Fig. 1.1: General presentation of the Robotiq Force Torque Sensors with main features.



## 1.1. Main features

### 1.1.1. FT 300 Force Torque Sensor

- The end-of-arm tool contact surface (in green) is the only point of contact allowed between the Sensor and the tool to ensure correct force and torque feedback.
- The robot contact surface (in blue) is the only contact point allowed between the Sensor and the robot for fastening the sensor to the robot. Note that the inside ring must not touch the robot.

#### Info

Details on the bolt pattern and indexing pin for the tool side and the robot side can be found in the **Specifications** section.

- The screw positioning for the coupling and the robot mountings are shown in orange. See the Spare Parts section for a list of available Couplings.
- M12 connector (pigtail or mounted) allows for both power and data transfer for the Sensor.
- Status LED provides visual information on the status of the Sensor, see Section 3.7 for details.

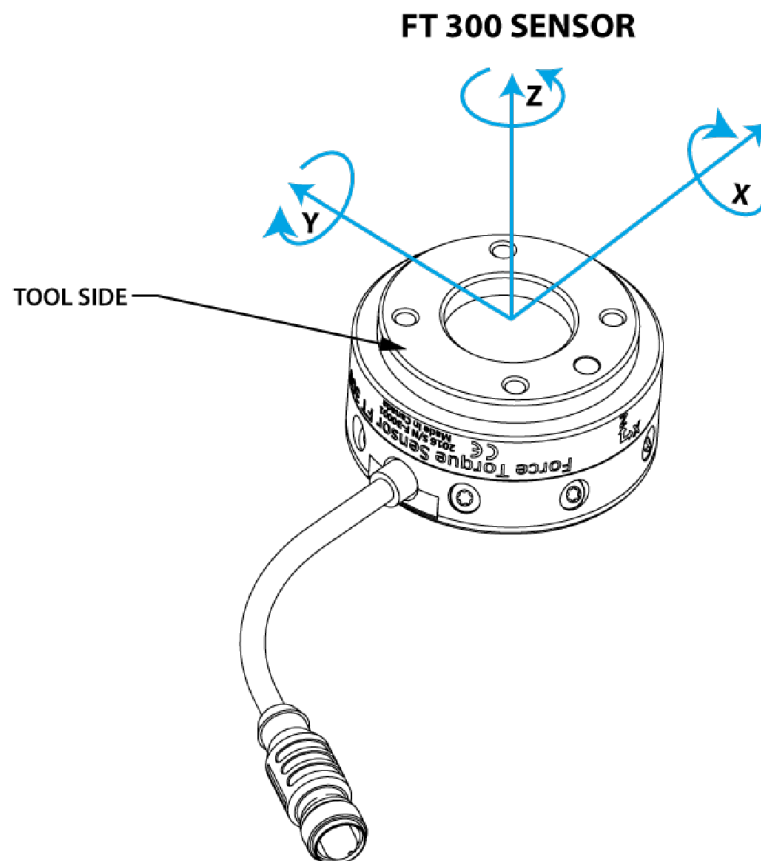

Fig. 1.2: FT 300 Force Torque Sensor force and torque diagrams.



The figure above represents the various force and torques that the FT 300 Force Torque Sensor can measure. Reference frame is centered on the Sensor as shown above and visual inscriptions are also represented on it.

- The Z axis passes through the center of the depression with positive direction in the tool direction.
- The X axis traces a symmetric line centered on the connector; the positive direction points the opposite way away from the connector.
- The Y axis uses the right hand thumb rule according to X-Z.

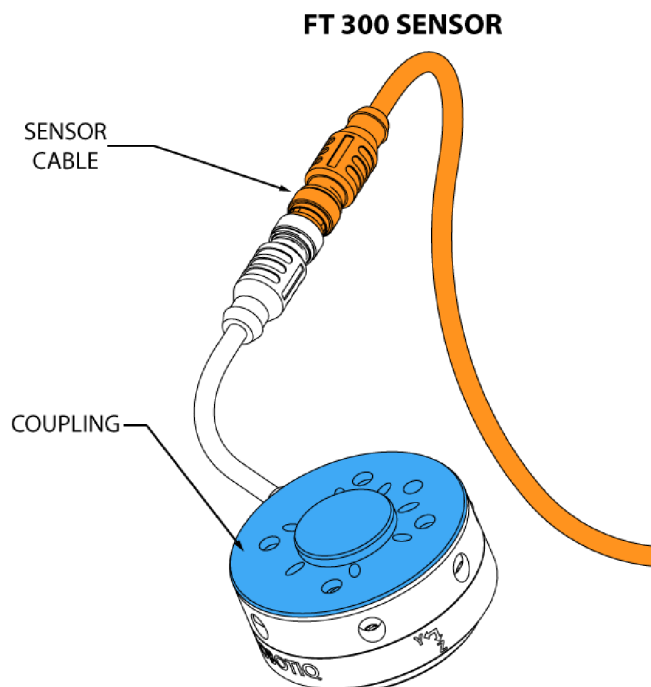

Fig. 1.3: FT 300 Force Torque Sensor options.

The figure above represents various options available. They can be found in the **Spare Parts, Kits and Accessories** section.

- **Couplings** are meant to install the FT 300 Force Torque Sensor on various robot models, see available models.
- **Sensor Cable** is used for power and communications with the FT 300 Force Torque Sensor and is available in different lengths.
- **Mechanical Protector** is meant to protect the cable connector from collisions that can occur when operating the robot (especially useful when in teach mode).
- **Tool Plate** is not shown, but might be required when certain end-of-arm tools are mounted on the FT 300 Force Torque Sensor.

#### Info

Please refer to the **Installation** section for details on the installation of various options.

Several software packages are provided and detailed in the **Software** section of this manual.

#### Tip

It is important to understand that the FT 300 Force Torque Sensor can be used either as a Modbus RTU slave or as a streaming device. When use as a slave unit you will send status requests (read function) to get the force & moment values, while when in data stream mode the Sensor will continuously stream data without responding to a master request. Please refer to the **Serial Communication** section for details.



## 1.1.2. Force Copilot

Force Copilot is the Robotiq software product that unlocks force control features and functionalities.

The Force Copilot software is used for the implementation of a force torque sensor's operational commands in a user interface.



---

## 2. Safety

---

### Warning

The operator must have read and understood all the instructions in this manual before handling the Robotiq Force Torque Sensor and using Force Copilot.

### Info

The term "operator" refers to anyone responsible for:

Any of the following operations with the FT 300 and the associated robot or tools:

- Installation
- Control
- Maintenance
- Inspection
- Decommissioning

Any of the following usage of Force Copilot and the associated operational commands:

- Installation
- Control
- Calibration
- Programming

This documentation explains the various components of the Force Torque Sensor, as well as general operations regarding the whole life-cycle of the product from installation to operation and decommissioning.

The drawings and photos in this documentation are representative examples and differences may exist between them and the delivered product.



## 2.1. Warning

### Info

Any use of Force Copilot and/or the Force Torque Sensor in noncompliance of these warnings is inappropriate and may cause injury or damage.

### Warning

A force torque sensor used in human-robot collaboration must not be considered a complete safety measure, additional dedicated safety device(s) must be considered. Sensor failure can occur and result in danger for workers or machinery. See local or international safety measure for human-robot collaboration.

### Warning

- The Sensor needs to be properly secured before operating the robot.
- Do not install or operate a Sensor that is damaged or lacking parts.
- Never supply the Sensor with an alternative current source.
- Make sure all cord sets are always secured at both ends, at the Sensor and at the robot.
- Always meet the recommended keying for electrical connections.
- Make sure no one is in the robot and/or Sensor path before initializing the robot's routine.
- Always meet the Sensor payload specifications.
- All local safety measures and/or laws on robot operation must be applied to the Sensor.
  - Any use of the Sensor in noncompliance with these warnings is inappropriate and may cause injury or damage.



## 2.2. Intended Use

The Sensor is designed for data acquisition (force and torque sensing) for an end-of-arm tool on a robot.

The Sensor is intended for installation on a robot or other automated machinery or equipment.

The software is used for the implementation of a force torque sensor's operational commands in a user interface.

### Info

Always comply with local and/or national laws, regulations and directives on automation safety and general machine safety.

The unit may be used only within the range of its technical specifications. Any other use of the product is deemed improper and unintended use. Robotiq will not be liable for any damages resulting from any improper or unintended use.



## 3. Installation

### Warning

Be sure to read and understand the safety instructions related to the Robotiq Force Torque Sensor prior to installation.

### 3.1. Scope of Delivery

Standard delivery for an FT Sensor kit:

FTS-300-KIT-001

Robotiq Force Torque Sensor FT 300 unit

1 m pigtail cable (CBL-COM-2068-01)

10 m Robotiq Device Cable (CBL-COM-2065-10-HF)

USB Signal Converter (ACC-ADT-USB-RS485)

#### 3.1.1. Options

- Couplings

#### Info

Coupling is mandatory for the FT 300.

- Adapter plates
- Tool plates
- Different cable lengths

#### Info

The following are not included in delivery unless specified in the purchase:

- Options such as couplings and adapters for mounting on divers industrial robots.
- Hardware required for options; accessories or fixtures for the FT Sensor unless specified.
- Power supply units, power supply wiring or fuses.

Please refer to the **Spare Parts, Kits and Accessories** section for a list of available parts.





## 3.2. Environmental and Operating Conditions

The FT 300 Force Torque Sensor is designed for industrial applications. Always respect the following specified storage, transport and operating environmental conditions:

CONDITION	VALUE
Minimum storage/transit temperature	-25°C
Maximum storage/transit temperature	70°C
Minimum operating temperature	15°C
Maximum operating temperature	35°C
Humidity (non-condensing)	20-80% RH
Vibration (storage / transit)	5G
Vibration (operating)	2G
Other	<ul style="list-style-type: none"> <li>• Free from dust, soot or water</li> <li>• Free from corrosive liquids or gases</li> <li>• Free from explosive liquids or gases</li> <li>• Free from powerful electromagnetic interference</li> </ul>

## 3.3. Mechanical Connections

You must use a coupling to attach the Sensor to a robot. Be sure to use the coupling related to your robot model. Our couplings are listed according to ISO 9409-1 and this covers most bolt patterns. If there is no coupling for your robot, you can modify a blank coupling or Robotiq can create a custom version for you. Some couplings may require an additional adapter plate. To create your own coupling or adapter plate you can refer to the **Technical Dimensions** section. To see available couplings and adapter plates and for details, refer to the **Spare Parts, Kits and Accessories** section.

### Info

The FT 300 coupling is mandatory, you can customize yours from a blank provided by Robotiq.

Here are the steps to follow for the installation of the Sensor (see figure below). Note that all screws must be locked in place using medium strength threadlocker, such as *Loctite 248* or a similar product.

1. Align the indexing dowel pin between the coupling and the robot (usually press fitted to the robot).
2. Screw the coupling to the robot with the robot mounting screws (with lock washers if provided) and threadlocker.
3. Align the Sensor indexing dowel pins (prefixed to the Sensor) to the coupling.
4. Screw the Sensor to the coupling using the coupling mounting screws (with lock washers if provided) and threadlocker.



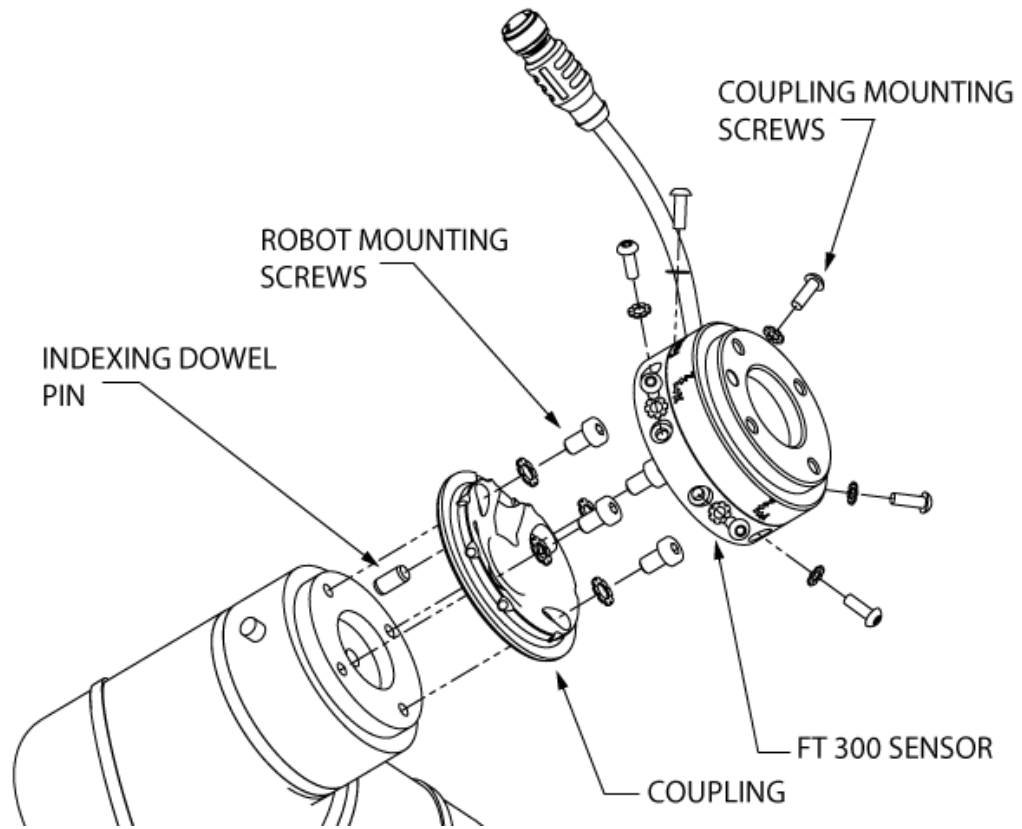

Fig. 3.1: Attaching the FT 300 sensor to a robot arm using the mandatory coupling.



## 3.4. Power Supply Specifications

The Sensor needs to be supplied by a DC voltage source. This power supply is not included with the Sensor.

POWER SUPPLY SPECIFICATIONS	VALUE
Output voltage	5 to 24 V DC
Max power consumption	2 W
Overcurrent	1 A Fuse (Phoenix #0916604 (UT6-TMC M 1A))
Overvoltage protection	<div style="border: 2px solid red; padding: 5px;"> <p><b>Warning</b></p> <p>Maximum output voltage tolerance is 10%, exceeding this limit, 26.4 V DC could damage the Sensor.</p> </div>

### Info

Robotiq recommends the use of the following power supply:

TDK-Lambda DPP Series, 15W Single Output DIN Rail Mount Power Supply, **DPP15-24**



## 3.5. Wiring

Power and communications are established with the FT 300 Force Torque Sensor via a single device cable. The FT 300 has a pigtail cable.

The figure below represents the FT 300 Force Torque Sensor receptacle (Sensor side) and connector (cable side) with associated pinout. The M12 - 5 pin A-coded connector is used in accordance with IEC 61076-2-101.

### Warning

**Use proper cabling management.** Be sure to have enough forgiveness in the cabling to allow movement of the Gripper along all axes without pulling out the connectors. Always protect the controller side of the cable connection with a strain relief cable clamp.

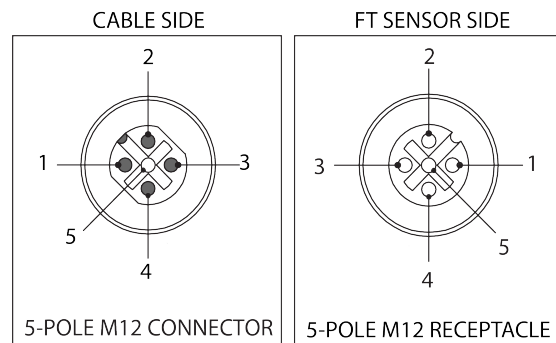

PIN	END OF CABLE COLOR	SIGNAL
1.	(SHIELD)	485 GND
2.	RED	24 V
3.	BLACK	GND
4.	WHITE	485 +
5.	GREEN	485 -

Fig. 3.2: Pinout of the Robotiq Force Torque Sensor FT 300 and color code for the respective cable type.

### Info

Power pins 2 & 3 are connected to the specified power supply.

### Info

RS-485 signal pins 1, 4 & 5 are connected directly, to a RS-485 / USB converter or to a RS-485 / RS-232 converter.



### 3.5.1. Wiring with USB to RS485 Converter

When using a RS485 to USB converter (refer to the **Spare Parts, Kits and Accessories** section), the wiring must respect the figure below and subsequent directions. GND / 0V is wired to Sensor pin #1 as stated in the **Wiring** section.

The converter will provide you with a standard USB 2.0 male A connector.

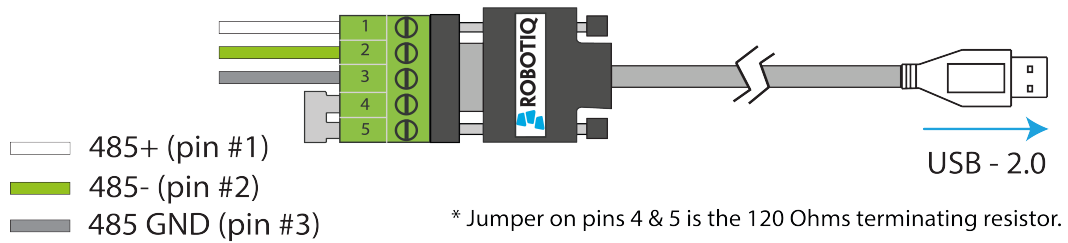

Fig. 3.3: Wiring diagram for the RS485 to USB converter

#### Warning

Power is not delivered via the USB, do not plug 24V into the USB.



### 3.5.2. Wiring with RS232 to RS485 Converter

When using a RS232 to RS485 converter (refer to the **Spare Parts, Kits and Accessories** section), the wiring must respect the figure below.

#### Warning

Do not wire converter pin #3 (5V) on the RS485.

The 24V power supply is NOT supplied via the converter.

The converted side will provide you with a standard DB - 9 female connector with signaling as shown in the figure below.

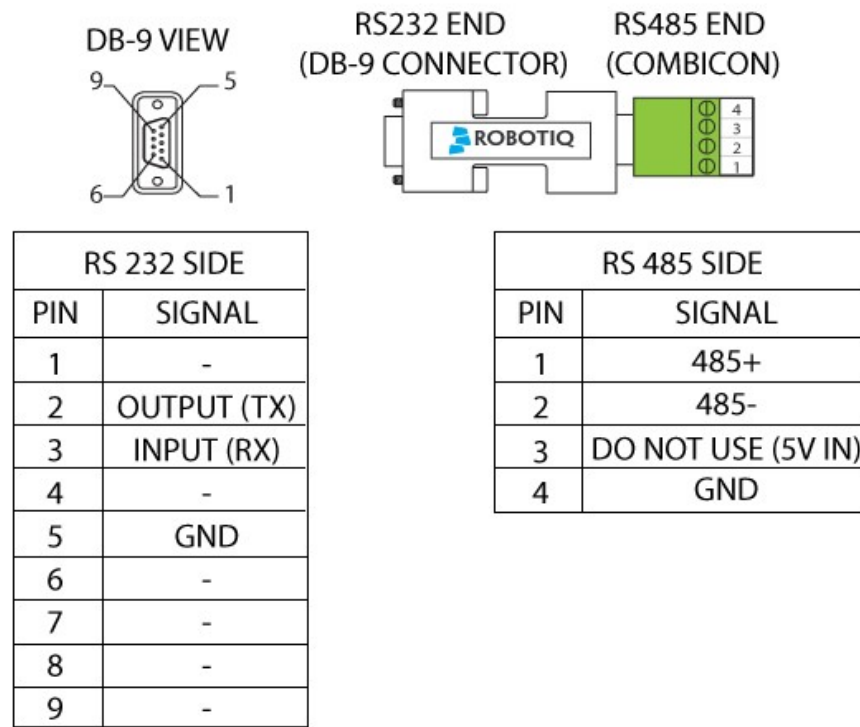

Fig. 3.4: Wiring diagram for RS232 to RS485 converter.



## 3.6. Installation for Universal Robots

The table below shows which Robotiq software to use with your version of Universal Robots' controller. If you are using a CB3 or CB3.1 controller, it is recommended to use the Force Copilot URCaps Package.

Robotiq Software	Universal Robots' controller version			
	CB1	CB2	CB3	CB3.1
Legacy Driver Package (DFU-1.1.15) (includes Gripper toolbar)	Incompatible	Compatible	Compatible	Compatible
ActiveDrive Toolbar (ADU-1.0.1)	Incompatible	Compatible	Compatible	Compatible
FT 300 Force Torque Sensor URCap Package up to 1.1.1 (includes ActiveDrive toolbar)	Incompatible	Incompatible	Compatible	Compatible
Force Copilot URCap Package (includes ActiveDrive toolbar)	Incompatible	Incompatible	Incompatible	Compatible

Refer to the appropriate section depending on your controller version:

- The **Force Copilot URCap Package** section covers the installation of the Force Copilot URCap Package.
- The **UR Package without URCaps** section goes through the software installation procedures when not using URCaps.

### Info

The robot's PolyScope version must be 3.5 and higher in order to install and use the URCap.

Prior to any software installation, connect the white, green and bare wires to the Robotiq RS-485 signal converter (ACC-ADT-RS485-USB) as shown in the figure below. Also connect the red (24V) and black (0V) wires in the controller according to the figure below.

### POWER SUPPLY WIRING (ACCORDING TO UR CONTROLLER MODEL)

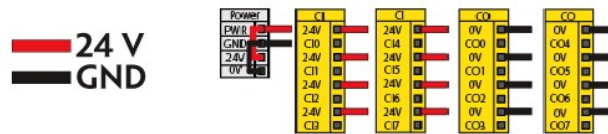

### COMMUNICATION WIRING

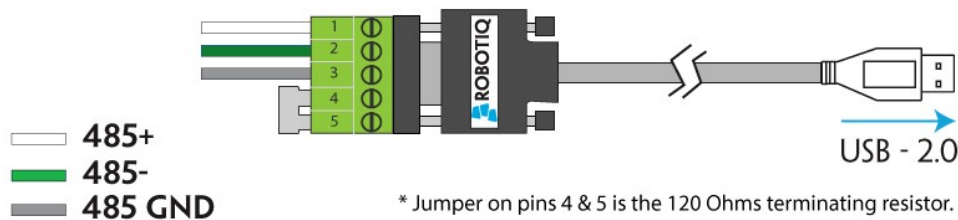

Fig. 3.5: Force Torque Sensor wiring to Universal Robots' controller.



### Info

Prior to use over Universal Robots, adjust the payload and the center of gravity from the Installation tab (refer to the **Moment of Inertia and Center of Mass** section).

## 3.6.1. Force Copilot URCap Package

### Info

The robot's PolyScope version must be 3.5 and higher in order to install and use the URCap.

## Installation

Follow this procedure to install the Force Copilot URCap Package.



URCap



Force Copilot version XXX-X.X.X

- Browse to [support.robotiq.com](http://support.robotiq.com)
- Select Force Copilot
- Download UCS-X.X.X.urcap
- Decompress the file on the USB license dongle
- Insert the USB license dongle in the robot teach pendant, robot controller, or USB hub connected to the robot controller

### Caution

Make sure that the license dongle stays connected to the robot.

- Make sure that your PolyScope version is up-to-date and that your Universal Robots controller is compatible with the Force Copilot URCap package. Refer to the **Control with Universal Robots** section for the UR controller compatibility.
- Go to [support.robotiq.com](http://support.robotiq.com) and click on the [product page of the FT 300 Sensor](#).
- Download the **Robotiq\_Force\_Copilot-X.X.X.urcap** file on a blank USB stick.
- Insert the USB stick in the UR teach pendant or controller.
- Go to **Setup Robot**.
- Tap **URCaps Setup**.

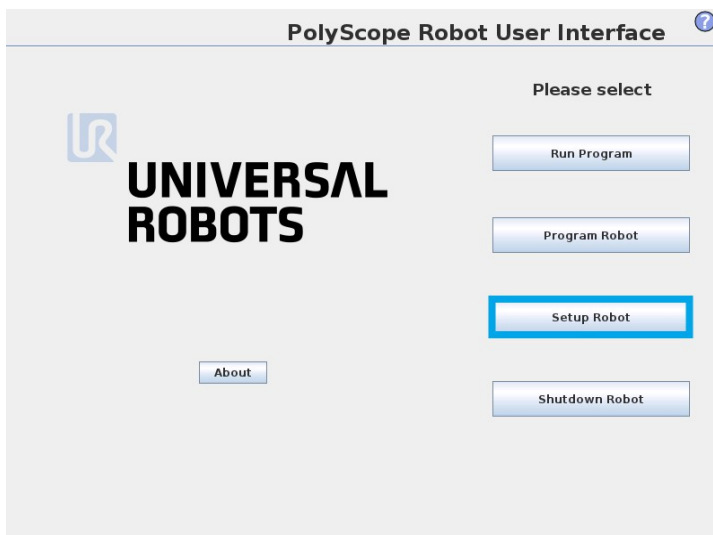



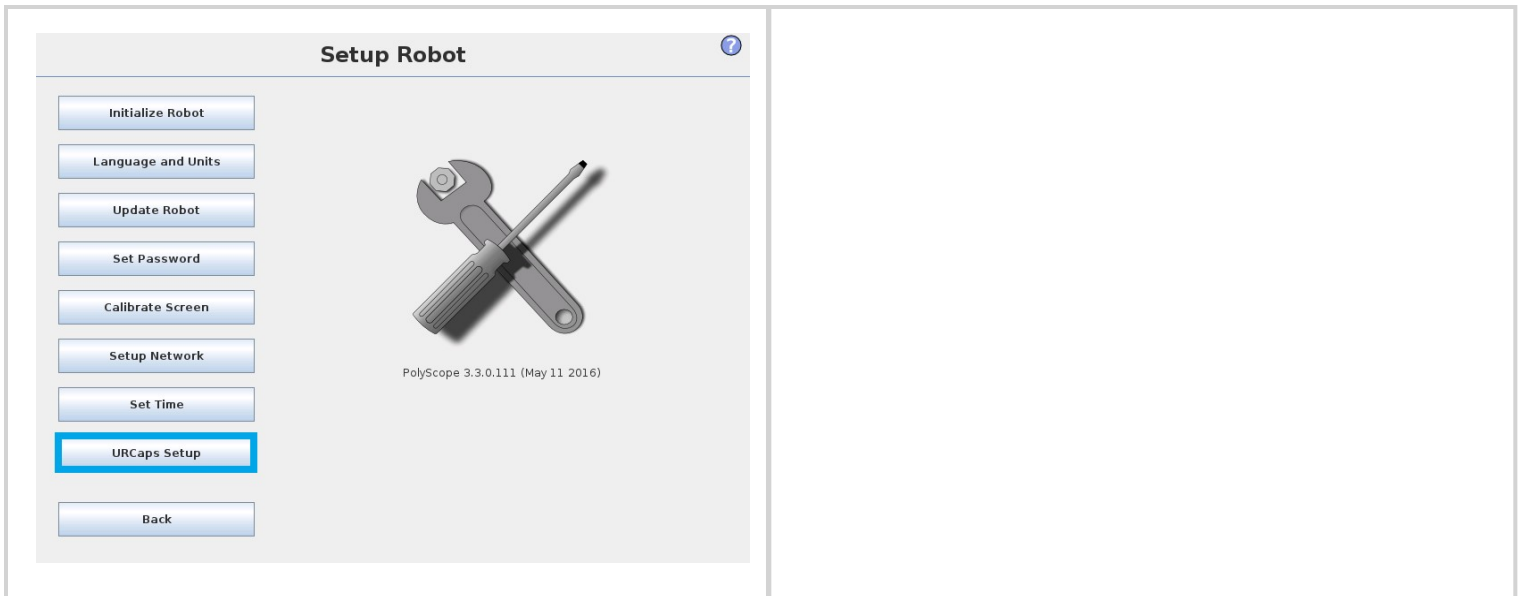

### Tip

Go to the PolyScope home page and tap the **About** button. A window containing the Universal Robots software version will pop up.

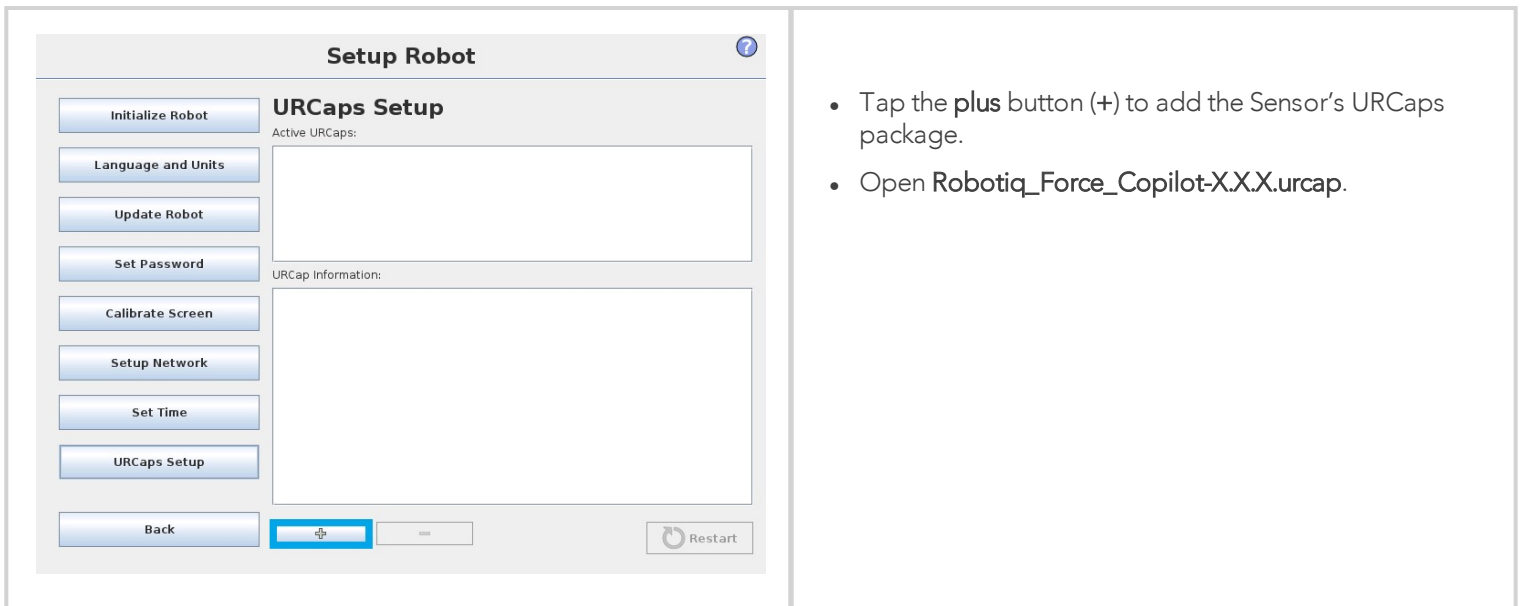

- Tap the **plus** button (+) to add the Sensor's URCaps package.
- Open `Robotiq_Force_Copilot-XXX.urcap`.

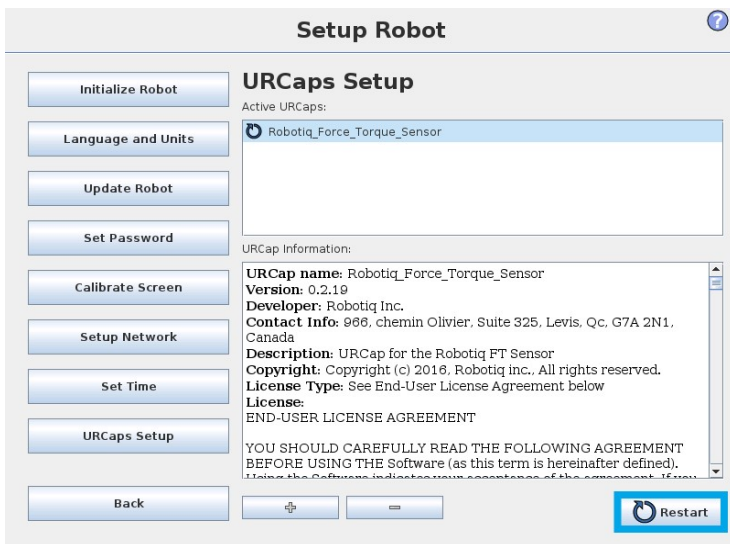

- Restart PolyScope to complete the URCap installation. By doing so, you accept the License Agreement that is detailed in the URCap Information text box (see below for the License Agreement).

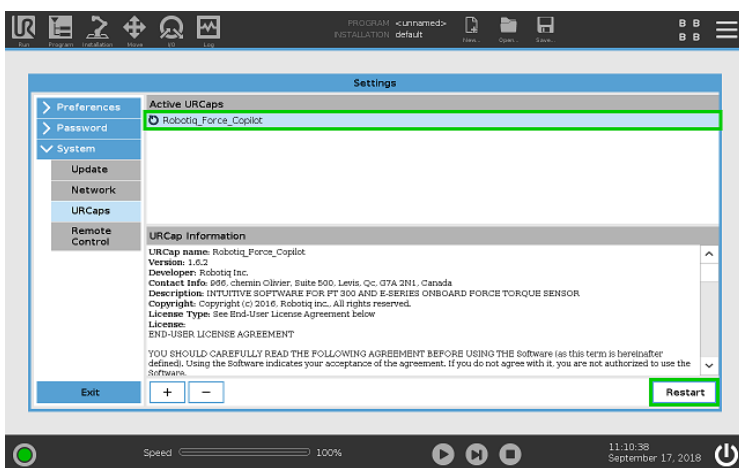

- When PolyScope reopens, the ActiveDrive toolbar will appear on the screen.

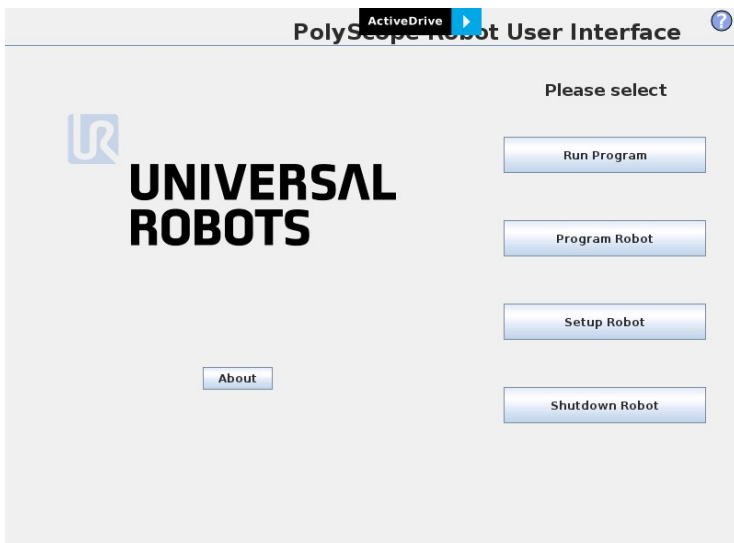

If the Force Torque Sensor is mounted on the robot for the first time, the calibration must be performed. Refer to the **Calibration Procedure with Universal Robots** section for the calibration procedure.

Warning



The sensor must be recalibrated after each uninstall / install on the robot. Mounting screws will induce internal stress that needs to be compensated for. Not doing so will significantly affect the sensor signal.



## Calibration Procedure

The sensor outputs the force and moment data according to a reference, i.e. a zero value. In order to compensate for any deviation of this reference, Robotiq provides a feature which allows the sensor to automatically compute and compensate the installation offset, the weight of the tool and its center of mass.

### Warning

The sensor must be re-calibrated after each uninstall / install on the robot. Mounting screws will induce internal stress that needs to be compensated for. Not doing so will significantly affect the sensor signal.

The procedure requires moving the robot arm in three configurations for which each orientation of the tool is different. Using an internal accelerometer, the sensor is then able to associate the measurements corresponding to the tool alone for each orientation. After the procedure is completed, the sensor will output the force and moment values measured without the effect of the weight of the tool and the installation offset.



## Calibration Procedure with Universal Robots

### Info

You need the Universal Robots software package installed first. Please refer to the [Installation for Universal Robots](#) section for the package download and installation.

- 1 On the teach pendant, tap the **Installation** button in the ribbon at the top of the screen.
  - 2 Select URCaps in the navigation pane on the left of the screen.
  - 3 Tap the Force Copilot button.
  - 4 Select the Calibration tab
- 1 From the PolyScope home page, tap **Program Robot**.

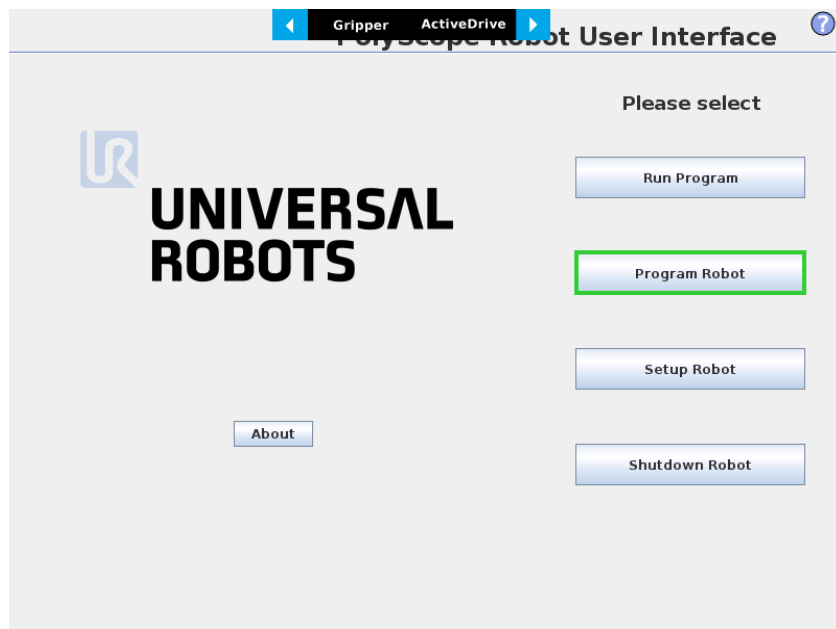

- 2 Go to the **Installation tab** and tap **FT Sensor** in the left pane. The FT Sensor's Dashboard will be displayed. Tap the **Calibration tab**.

File Gripper ActiveDrive 12:26:18 CCCC ?

Program Installation Move I/O Log

MODBUS  
Conveyor Tracking  
EtherNet/IP  
PROFINET  
FT Sensor  
Insights  
Camera  
Gripper  
skills-Free turning  
skills-Gripper Add-O  
skills-Linear Search  
skills-Rotation Search  
skills-Torque turning  
skills-Auto-Picking

Dashboard Calibration Configuration About

Robotiq Force Torque Sensor is not calibrated

Force Values		Moment Values	
Fx =	0.2 N	Mx =	0.01 Nm
Fy =	-1.0 N	My =	-0.02 Nm
Fz =	3.1 N	Mz =	0.02 Nm

Zero sensor



- 3 Tap the **Start calibration wizard** button to perform the calibration of the FT Sensor. Make sure there are no external forces applied to the Sensor while performing the calibration.

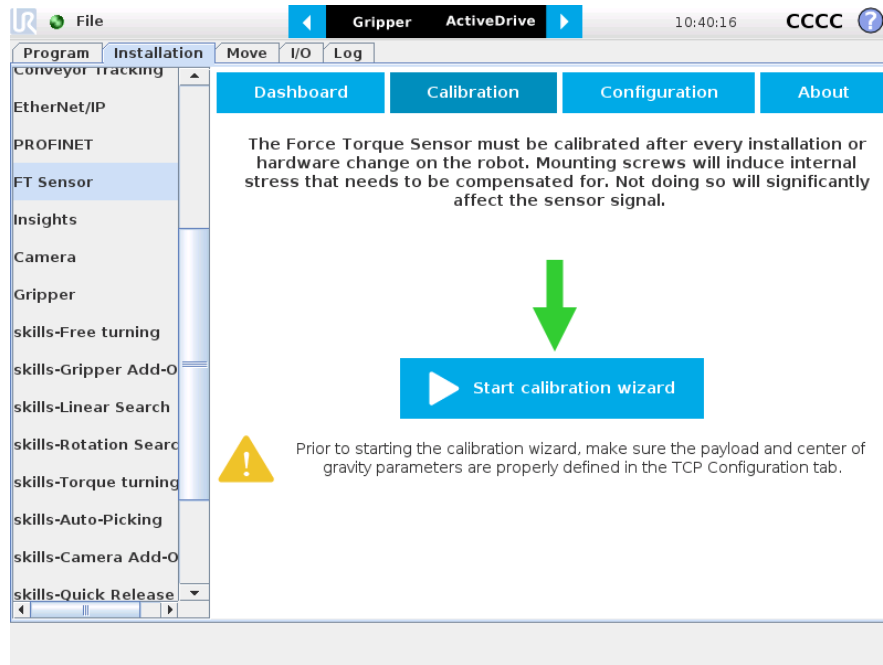

- 4 Step 1 consists in moving the robot arm so that the FT Sensor's X axis points downward. Tap Continue when the action is done.

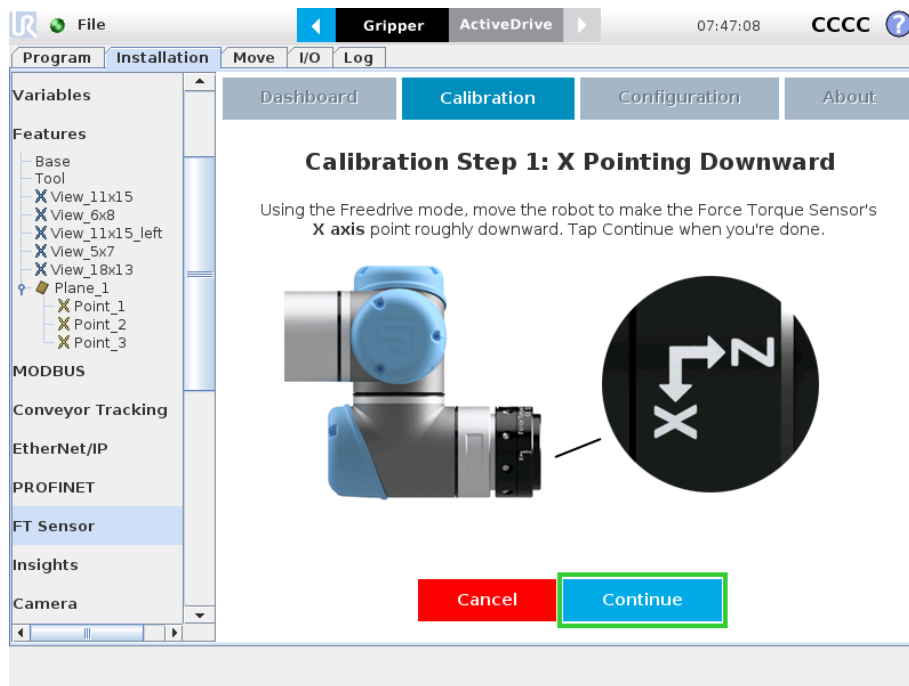

- 5 Step 2 consists in moving the robot arm so that the FT Sensor's Y axis points downward. Tap Continue when the action is done

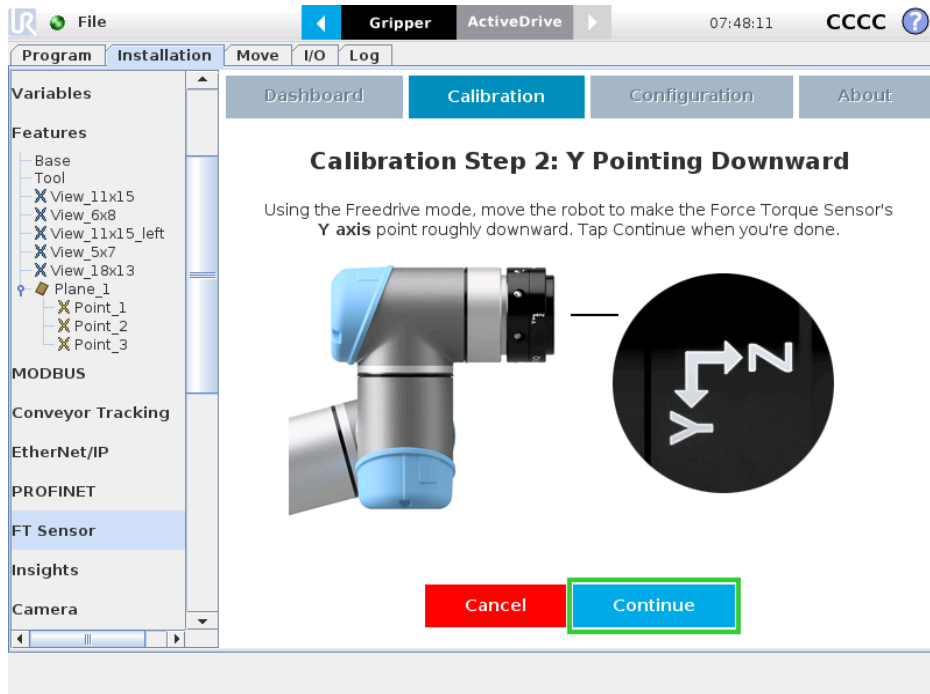

- 6 Step 3 consists in moving the robot arm so that the FT Sensor's Z axis points downward. Tap Continue when the action is done

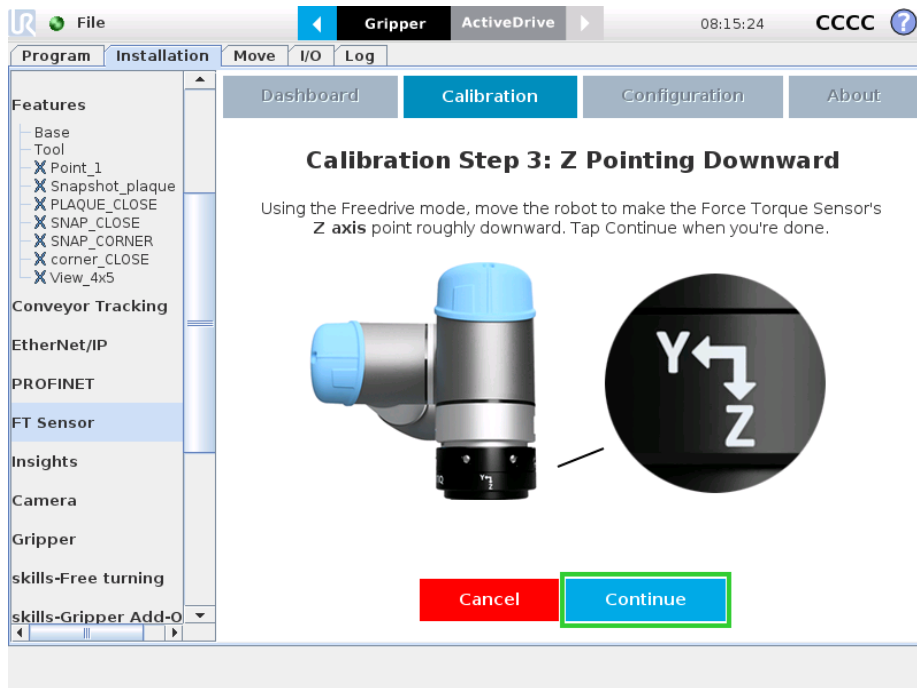

### Info

Recalibration is recommended in the event of an error message displaying the incorrect orientation of the FT Sensor during at least one calibration step.





## Calibration Procedure for the Visual Demo Software (PC)

### Info

You need the Visual Demo Software installed first. Please refer to the [Visual Demo Software](#) section for download and installation.

To calibrate your FT Sensor:

- 1 Go to the "Tool Calibration" tab and follow the instructions.



- 2 Once completed, go to the "Sensor Data" tab.

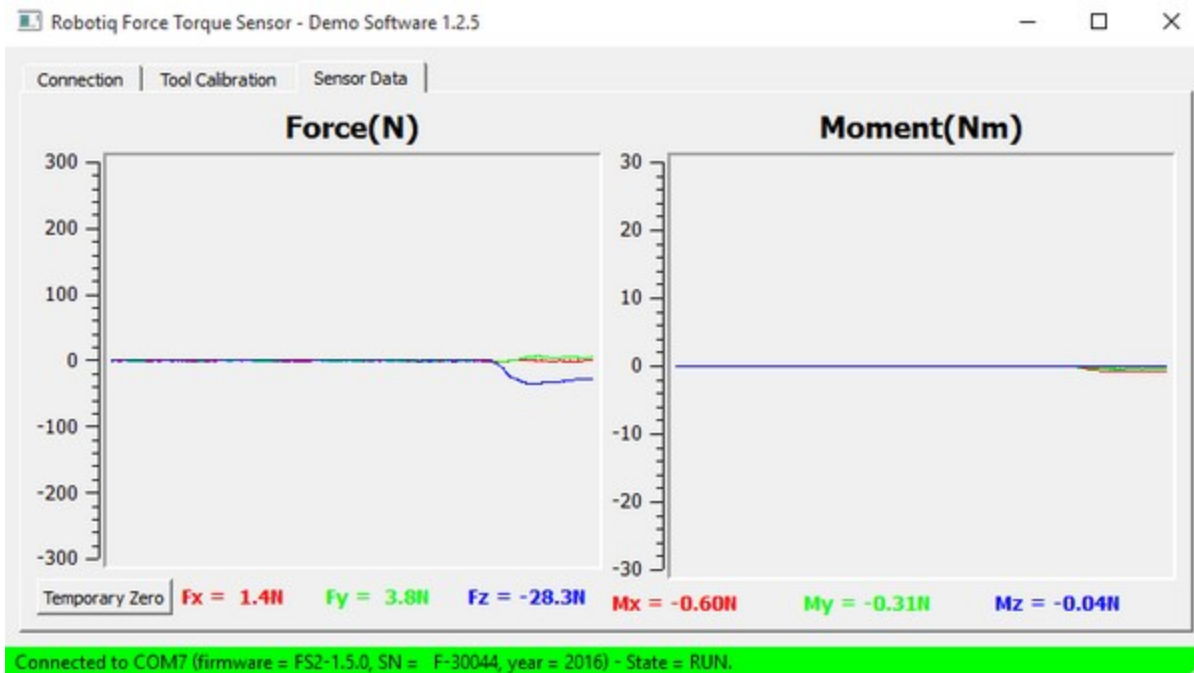

## Payload/CoG

The payload and center of gravity values can be accessed through the Calibration menu in the Installation tab, after the calibration is completed. They include the mass and center of gravity of the Sensor.

### Caution

The mass, payload or center of gravity of anything found under the Sensor (i.e. tool changer) will not be taken into account in the calculation of the payload.

### Warning

Make sure to save the installation file after performing the calibration. Saving will record the calibration date and estimate tool parameters.

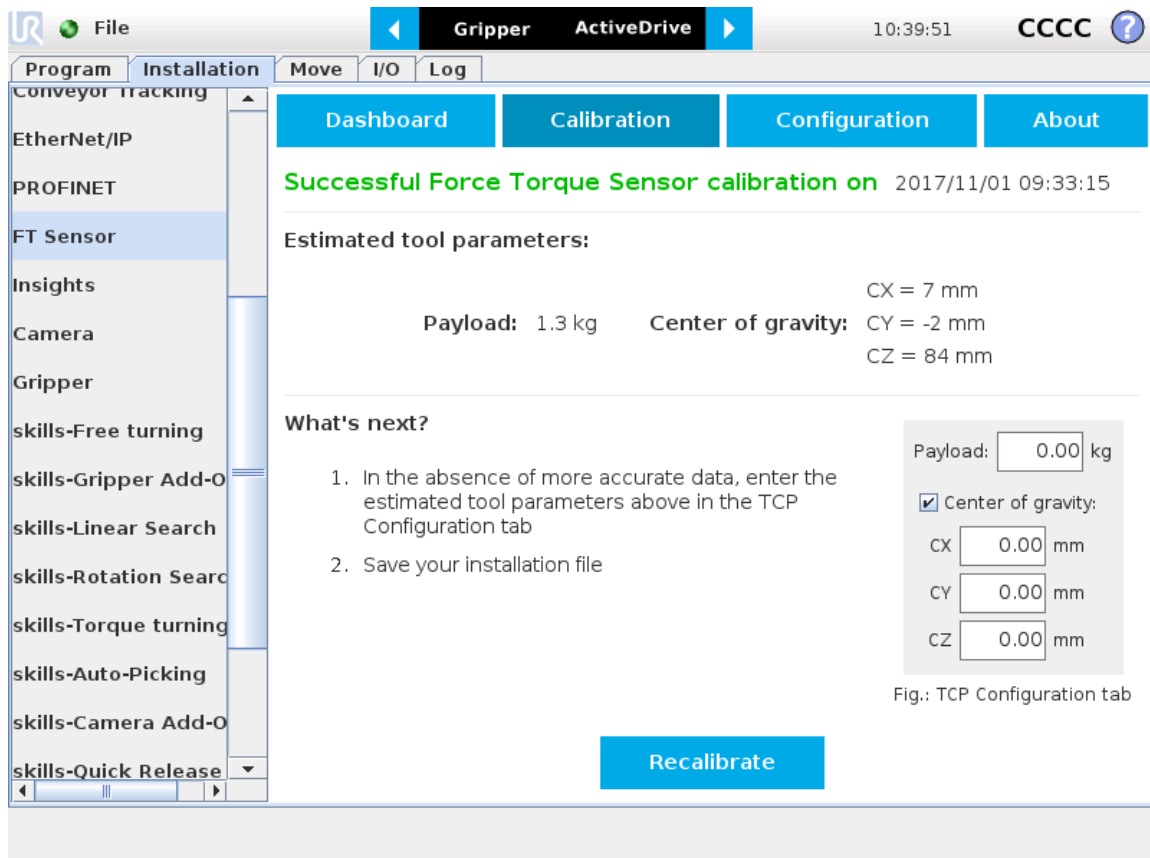

The screenshot shows the CCCC software interface with the 'Installation' tab selected. The 'Calibration' sub-tab is active, displaying a success message: 'Successful Force Torque Sensor calibration on 2017/11/01 09:33:15'. Below this, the 'Estimated tool parameters' are listed: Payload: 1.3 kg, Center of gravity: CX = 7 mm, CY = -2 mm, CZ = 84 mm. A 'What's next?' section provides two instructions: 1. In the absence of more accurate data, enter the estimated tool parameters above in the TCP Configuration tab; 2. Save your installation file. A 'Recalibrate' button is visible at the bottom. A separate window titled 'TCP Configuration tab' is shown, containing input fields for Payload (0.00 kg), Center of gravity (checked), and CX (0.00 mm), CY (0.00 mm), CZ (0.00 mm).



## ActiveDrive Toolbar Installation

### Tip

Prior to installing the ActiveDrive toolbar, the Sensor Driver package should be installed.

### Info

The URCaps package contains the ActiveDrive Toolbar. Therefore, installing the URCap package also installs the toolbar. If you have installed the URCap, you do not need to install the ActiveDrive Toolbar. This section applies to Robotiq's software installation when not using the URCap. If you wish to install the URCap package, refer to the **Force Copilot URCap Package** section.

### Tip

Make sure your PolyScope version is up-to-date and that your controller is compatible with the driver package for UR (refer to the **Installation for Universal Robots** section for controller compatibility). To view your PolyScope version, go to the home page of the teach pendant and tap the **About** button. A window containing the Universal Robots software version will pop up.

### Warning

Verify that the Force Torque Sensor is aligned with the robot arm using the dowel pin, or at least make sure the holes are aligned. This ensures that the Sensor's axes are aligned with the robot's and that the ActiveDrive will work correctly.

To install the ActiveDrive toolbar :

- 1 Visit [support.robotiq.com](http://support.robotiq.com) and download the latest ActiveDrive toolbar installer (ADU-X.X.X) in the [Documentation Archives section](#).
- 2 Extract the files on a blank USB stick.
- 3 Connect the USB stick in the Universal Robots' teach pendant or controller.
- 4 Installation is automatic. The pendant's screen will show installation status.
- 5 Do not remove the USB stick before the installation is completed.
- 6 Once the installation is completed, the ActiveDrive Toolbar button will appear on the teach pendant's screen after a short delay.

### Info

To get detailed information on how to use the ActiveDrive Toolbar, refer to the **ActiveDrive Toolbar** section.



## Firmware upgrade

A firmware upgrade might be necessary when updating the Force Copilot URCap. From the PolyScope home page, go to **Program Robot** and tap the **Installation** tab. Select **FT Sensor** in the left pane and tap the **Dashboard** button. If an upgrade is needed, the Upgrade firmware button will display. Tap the button and wait for the upgrade to be completed.

### Warning

Do not disconnect the Sensor during firmware upgrade.

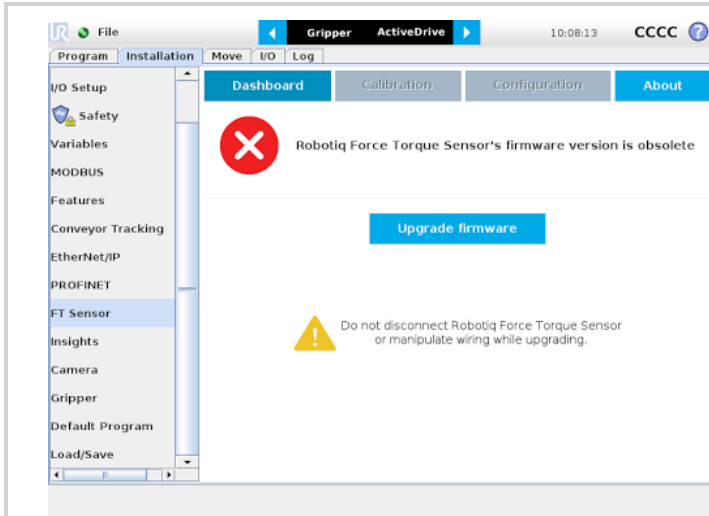

- Tap Upgrade firmware

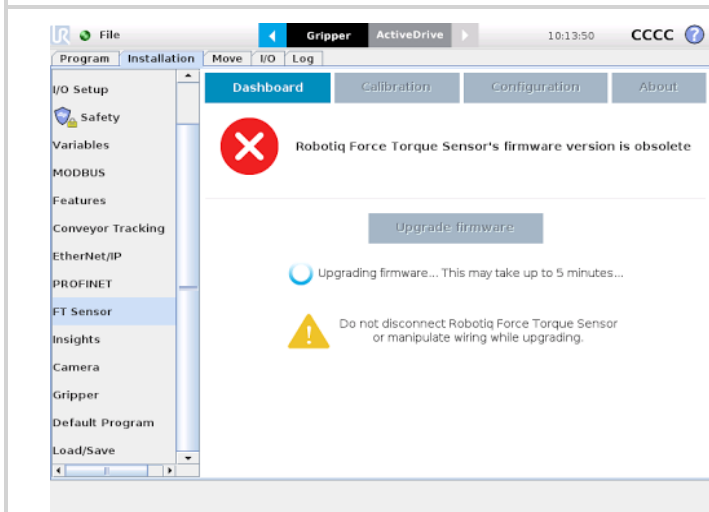

Wait while the software is upgraded.



## Uninstalling the URCap Package

If you wish to uninstall the Force Copilot URCap, follow this procedure:

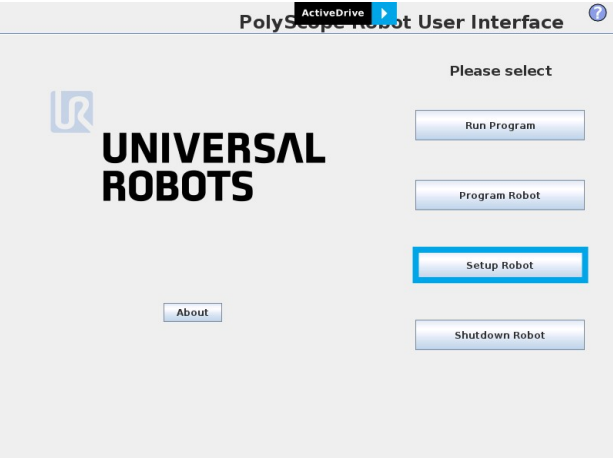
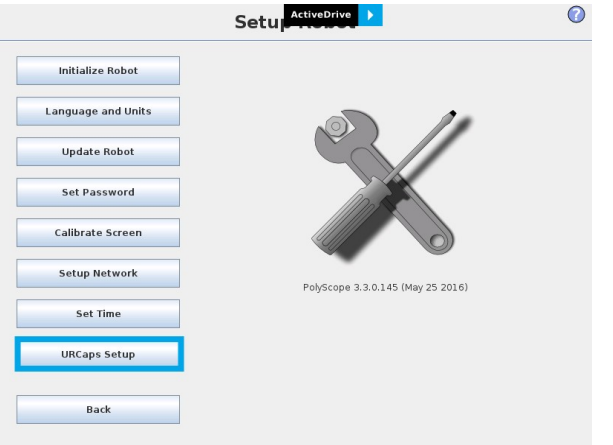
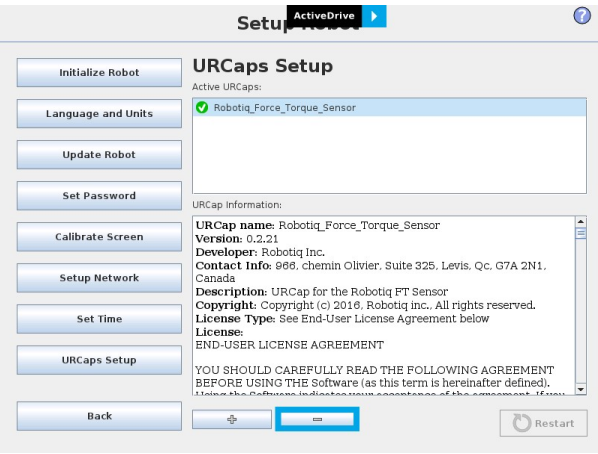
	<p>Go to <b>Setup Robot</b>.</p>
	<p>Tap <b>URCaps Setup</b>.</p>
	<ul style="list-style-type: none"> <li>• In the Active URCaps text box, tap the Force Copilot URCap.</li> <li>• The Force Copilot URCap should be highlighted.</li> <li>• Tap the <b>minus</b> button (-) to uninstall the URCap.</li> <li>• Restart PolyScope to complete the uninstallation process.</li> </ul>



# License Agreement

## END-USER LICENSE AGREEMENT

YOU SHOULD CAREFULLY READ THE FOLLOWING AGREEMENT BEFORE USING THE SOFTWARE (as this term is hereinafter defined). Using the Software indicates your acceptance of the agreement. If you do not agree with it, you are not authorized to use the Software.

**IMPORTANT, READ CAREFULLY:** This End-User License Agreement (the "Agreement") is a legal agreement between you and the Licensor (as this term is hereinafter defined), the licensor of the Software. This Agreement covers the Software. The Software includes any "on-line" or electronic documentation and all modifications and upgrades related thereto. By downloading, installing, or otherwise using the Software, you agree to be bound by the terms of this Agreement. If you do not agree to the terms of this Agreement, the Licensor cannot and does not license the Software to you. In such event, you must not download, use or install the Software.

### 1. Definition.

- 1.1. "**UR**" means Universal Robots A/S, a corporation incorporated under the laws of Denmark, having its registered office at Energivej 25, DK-5260 Odense S, which specializes into the conception, advanced manufacturing and sale of robotic products (the "UR's Business");
- 1.2. "**Software**" means any of the Licensor's software provided to its customers for the purposes mentioned in sub-section 2.2 hereof including their modifications and upgrades and their related materials;
- 1.3. "**Licensor**" means Robotiq inc., a corporation incorporated under the laws of Quebec, having its registered office at 500-966 chemin Olivier, Lévis, Québec, Canada, G7A 2N1, which specializes into the conception, advanced manufacturing and sale of robotic products (the "Licensor's Business");
- 1.4. "**End-User**" means a customer authorized pursuant to this Agreement to install or use the Software with a specific product of the UR's Products;
- 1.5. "**Licensor's Products**" means those robotic products developed by the Licensor in the course of the Licensor's Business;
- 1.6. "**UR's Products**" means those products developed by UR in the course of the UR's Business;
- 1.7. "**Licensor's Authorized Representatives**" means and includes the Licensor and Licensor's authorized vendors, resellers, distributors and licensors;
- 1.8. "**Designated Equipment**" means a personal computer that has a functional USB port and an operating system that is an equivalent or a more recent version of one of the following:
  - Windows 7;
  - Mac OSX;
  - Linux Ubuntu 16.
- 1.9. "**Purchase Agreement**" means an agreement between the End-User and the Licensor pursuant to which the End-User purchased one or more of the Licensor's Products;
- 1.10. "**Trial Period**" means the limited period during which the Software may be installed on the UR's Product and used without any charge by the End-User in order to be used without a Licensor's Product.

### 2. License and Object of the Agreement.

- 2.1. **License.** Subject to the terms and conditions hereof, the Licensor grants to the End-User a personal, temporary, non-exclusive, non-assignable and non-transferable and revocable license to use the Software in accordance with the terms and conditions hereof.
- 2.2. **Object of the Agreement.** The object of this Agreement is the grant of a license for the use of software that enables control functionalities of UR's Products devices or Licensor's Products (the "Purpose").



### 3. Software and Documentation.

3.1. **Download.** The Software shall be downloaded from the Licensor's website or provided to the End-User through a USB flash drive, according to the instructions set forth in the order summary sent to the End-User by email or by other means of communication, as decided by the Licensor (the "Order Summary"). The download of the Software shall be made with the End-User's Designated Equipment.

3.2. **Installation.** The installation on the UR's Product shall be done with a USB flash drive inserted into the UR's Product. If the Software was downloaded from the Licensor's website, it shall be uploaded on a USB flash drive device for the purpose of installation on the UR's Product.

3.3. **Utilisation.** Two scenarios are possible according to the modalities set forth in the Order Summary:

a) The use of the Software is made with a Licensor's Product. In this case, the End-User may start using the Software upon completed installation.

b) The use of the Software is made without a Licensor's product. In this case, a Trial Period is granted to the End-User. At the end of the Trial Period, which shall be set forth in the Order Summary, the use of the Software requires the software protection dongle (the "Dongle"). The Dongle will be provided to the End-User for a fee as per section 5 of this Agreement, either by the Licensor or by a Licensor's Authorized Representative.

3.4. **Documentation.** The Licensor may provide, if applicable, all documentation containing the detailed specifications for operation and use of the Software, which Software shall be used in accordance with such documentation. This documentation, if applicable, will be provided, wholly or in part, within (i) this Agreement, (ii) the Licensor's Web site <http://robotiq.com/> (iii) the Licensor's Products and the Purchase Agreement therewith, or (iv) any other agreement, document, support, whatsoever decided by the Licensor.

4. **Modifications and Upgrades.** The Licensor shall be under no obligation to provide any upgrade, modification or patch to the Software. However, the End-User shall be entitled to receive free of charge the upgrades and patches of the Software provided by the Licensor if, at such time, the End-User is not in default in respect of any of its obligations contained herein. Modifications that create new functionalities may be offered to the End-User at a price set by the Licensor at its sole discretion.

Such modifications, upgrades and patches of the Software shall be installed by the End-User itself by consulting the Licensor's website <http://robotiq.com/> where a link to proceed to such installation will be made available thereof.

5. **Fees.** The End-User shall pay the Licensor for using the software as per the Order Summary. The fees shall cover upgrades and patches of the Software provided by the Licensor if, at the time of the upgrade or patch, the End-User is not in default in respect of any of its obligations contained herein.

New End-Users not using the Licensor's Products will be entitled to a Trial Period, which shall begin on the date of the first installation on the UR's Product and which shall end after the Trial Period as determined in the Order Summary.

6. **Maintenance.** During the term of this Agreement, the Licensor will maintain the Software in an operable condition and will make available any corrections and improvements as are generally incorporated in the Software by the Licensor without additional charge to the End-User.

7. **Title to Software.** The licensed Software is composed of confidential data and trade secrets and is proprietary to and constitutes trade secret information and intellectual property of the Licensor. Title and ownership rights to the Software, including the intellectual property rights related thereto, shall remain with the Licensor. The End-User agrees to maintain the confidential nature of the source code and libraries.

The license granted herein does not include the right to sublicense to others, and may not be assigned to others, in whole or in part, without the prior written consent of the Licensor. The End-User may not or allow others to modify or prepare derivative works, copy (except for normal backups for recovery purposes), reproduce, republish, reverse engineer, upload, post, transmit, or distribute, in any manner, the Software.

8. **Restricted Use.** The Software shall be used solely and exclusively by the End-User and its employees for the Purpose mentioned in sub-section 2.2 hereof. Any other use of the Software, including resell derivative modifications or extensions, is expressly prohibited.

9. **Audit.** During the term of this Agreement and for six (6) months after the termination, the Licensor shall have the right, during normal business hours and upon reasonable advance notice to the End-User, to visit the End-User's premises for the purpose of



auditing the End-User's use of the Software to confirm that such use is in accordance with this Agreement or to confirm that the End-User has ceased the use of the Software after the termination of the Agreement. The costs of such audit shall be borne by the Licensor unless it determines that the End-User has underpaid it for any twelve-month period by five per cent (5%) or more or that the use of the Software is not in accordance with the Agreement; in such case, the End-User shall pay the costs of the audit and such underpayment.

10. **Exclusion of Warranty on Software.** The End-User expressly acknowledges and agrees that use of the Software is at the End-User sole risk. The Software is provided "as is". The Licensor warrants that, during the term of this Agreement and except if modified by the End-User, the Software will meet in all material respects the specifications provided for in the Licensor's website.

11. **Limitation of liability.** To the maximum extent permitted by law, the Licensor and Licensor's Authorized Representatives shall not be liable for any indirect, incidental or consequential damages for breach of any express or implied warranty, breach of contract, negligence, strict liability or any other legal theory related to the Software. Such damages include, but are not limited to, loss of profits, loss of revenue, loss of data, loss of use of the product or any associated equipment, down time and user's time, even if the Licensor has been advised of the possibility of such damages. In any case, the Licensor's entire liability under any provision of this agreement shall be limited to the amount actually paid in respect of the Licensor's products purchased by the end-user pursuant to a purchase agreement.

12. **Indemnification.** The End-User shall indemnify and hold the Licensor harmless from any liability, loss, claim and from any judgment, damage and cost (including, without limitation, the costs and fees of a dispute and reasonable legal fees), fine, penalty and interest whatsoever arising from any defence, dispute, compensation, claim or counterclaim as a result of the use of the Software by any third party authorized by the End-User.

13. **Training, Maintenance and Support.** There is no entitlement to training, maintenance and support under this license unless otherwise specified in the Purchase Agreement or any other written agreement between the End-User and the Licensor. The End-User may provide the Licensor with details regarding any bug, defect or failure in the Software promptly and with no delay from such event; the End-User shall comply with the Licensor's request for information regarding bugs, defects or failures and furnish him with information, screenshots and try to reproduce such bugs, defects or failures upon Licensor's demand.

14. **Expiration and Termination.** The Licensor may terminate this Agreement for default by the End-User by sending a ten (10) day notice to the End-User.

Upon the termination of this Agreement for any reason, the End-User shall promptly uninstall the Software on any UR's Products and Licensor's Products, computer, or server on which it has been installed, deliver to the Licensor all CDs, DVDs, USB flash drives, and other tangible items and materials embodying the Software, and return to the Licensor all copies thereof or destroy such copies and warrant in writing that all copies thereof have been destroyed or deleted. In the event of the termination of this Agreement, all obligations of the parties under this Agreement due for performance on the date of termination shall survive the termination, and the party terminating shall not be liable to the other party for any damages arising out of the termination.

#### 15. **Miscellaneous.**

15.1. This Agreement constitutes the entire understanding and agreement between the Licensor and the End-User and replaces any prior agreement relating to the same subject matter.

15.2. This Agreement shall be governed and construed in accordance with the laws of the province of Quebec and the federal laws of Canada applicable therein. Any legal action or proceeding between the Licensor and the End-User for any purpose concerning this Agreement or the parties' obligations hereunder shall be brought exclusively in a court of competent jurisdiction sitting in the judicial district of Québec, Québec.

15.3. The Licensor's failure to insist upon or enforce strict performance of any provision of this Agreement shall not be construed as a waiver of any provision or right. Neither the course of conduct between the parties nor trade practice shall act to modify any provision of this Agreement.

15.4. The Licensor may assign its rights and duties under this Agreement to any party at any time without notice to the End-User. The End-User may not assign this Agreement without the prior written consent of the Licensor.

15.5. If any part of this Agreement is null, illegal or non-enforceable, this Agreement shall be interpreted as if this part was never part of this Agreement.

15.6. The provisions of this Agreement are for the benefit of the Licensor and its officers, directors, employees, agents, licensors and suppliers. Each of these individuals or entities shall have the right to assert and enforce those provisions directly against the





End-User on its own behalf. This Agreement is also for the benefit of, and binds, the End-User and its heirs, successors, legal representatives and permitted assigns.

15.7. The Licensor hereby confirms that there is no relationship of agency between the Licensor and UR, and that they are independent contractors.

15.8. Any rights not expressly granted herein are reserved.

15.9. The parties confirm that they have agreed that this Agreement and all related documents be drafted in English only. Les parties aux présentes confirment qu'elles ont accepté que la présente convention et tous les documents y afférents soient rédigés en anglais seulement.



## 3.6.2. UR Package without URCaps

If your Universal Robots controller is not compatible with the URCaps package (refer to the **Installation for Universal Robots** section for compatibility), you can install the driver package and ActiveDrive Toolbar separately.

The ActiveDrive Toolbar allows to easily move the robot by hand guiding it. This section applies to Robotiq's software installation when not using URCaps.

### Info

The driver package and the ActiveDrive toolbar have separate installation processes. The driver package is independant from the ActiveDrive toolbar, but has to be installed beforehand if you wish to install the ActiveDrive toolbar.

## Driver Package Installation

### Info

The URCap package contains the driver package. Therefore, installing the URCap package also installs the driver package. If you have installed the URCap, you do not need to install the driver package. This section applies to Robotiq's software installation when not using the URCap. If you wish to install the URCap package, refer to the **Force Copilot URCap Package** section.

### Caution

Make sure your PolyScope version is up-to-date and that your controller is compatible with the driver package for UR (refer to the **Installation for Universal Robots** section for controller compatibility). To view your PolyScope version, go to the home page of the teach pendant and tap the **About** button. A window containing the Universal Robots software version will pop up.

To install the driver package, follow this procedure:

- 1 Download the Robotiq Force Torque Sensor software driver package (DFU-X.X.X) from the Documentation Archives.
- 2 Extract the content of the .zip file on a blank USB flash drive.
- 3 Plug the flash drive into the robot controller or teach pendant.
- 4 Installation is automatic. The pendant screen will show installation status. Do not unplug the flash drive until the operation is completed.
- 5 When a green "USB" text is shown, unplug the USB drive.

## Calibration

If the Force Torque Sensor is mounted on the robot for the first time, calibration must be performed. Refer to the **Calibration Procedure** section for details.

### Warning

The Sensor must be calibrated after each uninstall / install on the robot. Mounting screws will induce internal stress that needs to be compensated for. Not doing so will significantly affect the Sensor signal.



## Testing the software package

- In PolyScope, load the program test\_sensor.urp located in the Sensor folder and execute it. The program will display pop-ups with the following information: Sensor firmware version, production year and serial number. The force and torque readings for Fx, Fy, Fz, Mx, My and Mz are displayed in the Variables tab.

### Info

To get detailed information on how to program in PolyScope using the Force Torque Sensor signals, refer to the **Using the force and torque values** section.

## Removing the Package

- 1 Locate the uninstall.sh file provided in the driver package.
- 2 Copy the file on a blank USB stick.
- 3 Rename the file to urmagic\_uninstall.sh.
- 4 Plug the USB stick into the UR controller or teach pendant.
- 5 Uninstallation is automatic.



## 3.7. Status LED

A single status LED provides information on both Sensors, detailed information can be found in the tables below, while a representation of both Sensor status LEDs is shown in the figure below.

On the FT 300 Sensor, the cable sleeve is the LED conductor:

COLOR	LED STATE	INFORMATION
-	off	No power
Blue / red	on	FT 300 Sensor is booting
Red	on	FT 300 Sensor is functional, no communication detected
Red	blinking	FT 300 Sensor fault detected
Blue	on	FT 300 Sensor is functional, communication established

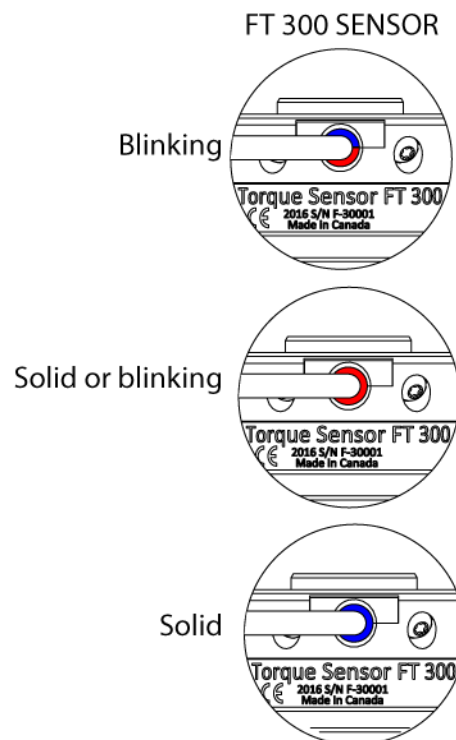

Fig. 3.6: FT Sensor status LED.



---

## 4. Software

---

The following sub-sections provide instructions for the installation of the Force Copilot software package. This allows you to get data from a force torque sensor.

- Section 4.1 and subsections refers to the control and programming for Universal Robots.
- Section 4.2 and subsections detail the installation of an open source development package, which can be adapted according to the users' needs. It currently functions with Windows and Linux.
- Section 4.3 links to ROS.
- Section 4.4 explains the Demo Software
- Section 4.5 will detail the use of serial communication in generic applications



## 4.1. Control with Universal Robots

Force Copilot contains many features to program and control the robot's arm using a sensor's force and torque readings. The package provides:

- ActiveDrive toolbar;
- Path recording node;
- Zero FT Sensor node
- Insertion node
- Find Surface node
- Force Control node
- Multipoint Path node
- Driver package.



## 4.1.1. ActiveDrive Toolbar

The ActiveDrive Toolbar is automatically installed with the Force Copilot software Package. It enhances the guiding mode on Universal Robots by allowing the robot to be hand guided smoothly and easily towards a waypoint. The ActiveDrive feature is a great way to assist the Path recording described in the **Path Recording** section, by hand guiding the robot while recording a path.

### Info

The Force Copilot software Package contains the ActiveDrive Toolbar. Therefore, the toolbar is automatically installed with the URCap Package.

### Info

The ActiveDrive Toolbar can be installed and used without the URCap Package (refer to the **UR Package without URCaps** section for information on how to install the toolbar without the URCap).

### Warning

Verify that the Force Torque Sensor is aligned with the robot arm using the dowel pin. This ensures that the Sensor's axes are aligned with the robot and that the ActiveDrive feature will work correctly.

The robot speed set with the Speed slider will affect the speed at which the robot moves in the ActiveDrive mode. Verify and adjust the speed slider to the desired speed. It has to be greater than 50%.

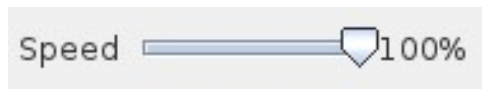

## Overview

### Toolbar collapsed



Tap the ActiveDrive button to expand the toolbar.

### Toolbar expanded









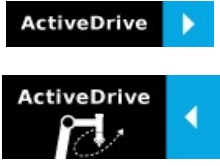

(Tap the mode selector to expand.)



### ActiveDrive modes expanded



## Features

Primary icon	Functionality name	Description
	ActiveDrive	Tap to toggle between the expanded and collapsed ActiveDrive Toolbar. When grey, the functionality is not available. Tap the button to see why it is not available.
	Start / Stop	<p>Tap to start or stop ActiveDrive. ActiveDrive will automatically turn off after 30s of inactivity.</p> <p>When started, ActiveDrive allows you to move the robot freely by applying forces on robot's end-effector. This is different from the Free Drive feature on the robot, where you can move the robot arm.</p>
	Modes	Shows the current ActiveDrive mode. When tapping the icon, the available modes will appear and you can change to a different mode. ActiveDrive modes allow you to restrain the robot to specific movements.
	Free	Free motion: all translations and rotations are allowed.
	Scara	SCARA-style motion: all translations and horizontal rotation (twist) are allowed.
	Translation	Translation motion: only translations are allowed. No rotation of the robot is possible in this mode.
	Plane	Plane motion: horizontal translations and horizontal rotations (twist) are allowed (no vertical motions are allowed).
	Drift Control	Tap this button to stop the robot from drifting (resets the sensor's offset).



Primary icon	Functionality name	Description
	Speed	<p>Motion speed control is toggled between fast and slow, allowing precise movement in slow motion.</p> <p>The force torque sensor will switch to slow speed automatically whenever high forces are detected, for example, during an impact with an object.</p>
	Square robot	Aligns the tool center point (TCP) orientation with the robot base. Tap and hold this button to automatically move the end-effector to the closest orthogonal orientation of the base axis system (just try it, you will see!).



## Error Messages Overview

The ActiveDrive Toolbar will be automatically collapsed and be grayed whenever one of the following situations occurs. In such cases, by tapping the ActiveDrive button, the following messages will appear:

- Message:



- Solution:

- Starting ActiveDrive while an excessive force is applied to the tool:
  - Determine if an external force is applied to the end-effector. If it is the case, tap **OK** and move the robot away from the obstacle (with Free Drive or Move tab), or remove any external forces and start ActiveDrive again.
  - If no external forces are applied, tap **Zero Sensor**.

- Message:

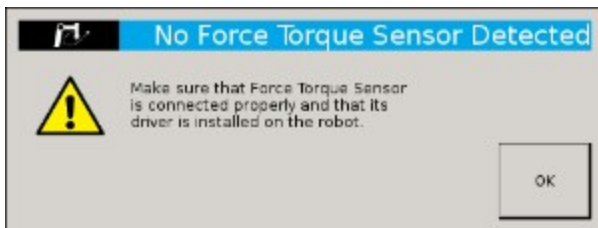

- Solution:

- Force Torque Sensor is detected: Check the Force Torque Sensor's connection. Make sure the USB adapter and all the wires are connected. Also, verify the Sensor's LED status (refer to the **Status LED** section).

- Message:



- Solution:

- The robot is not initialized: Tap **OK** and go to PolyScope's home page. Tap **Setup Robot** and go to **Initialize Robot** to start the robot.



- Message:



- Solution:

- A program is already running: The ActiveDrive Toolbar cannot be used while a program is running. Stop the program to enable the ActiveDrive feature.

- Message:



- Solution:

- The speed setting of the robot is lower than 50%: The robot's speed setting should be greater than 50%. Modify the speed setting in the robot program using the slider.

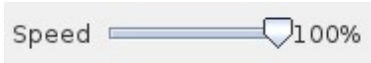

- Message:



- Solution:

- If the Freedrive button is pressed: The ActiveDrive mode cannot be used when the Free Drive mode is ON. Make sure you are not pressing on the teach pendant's Teach button when trying to use the ActiveDrive toolbar.



## 4.1.2. Using the force and torque values

Force Torque Sensor functions are made available in the Universal Robots functions drop-down menu.

- The `rq_zero_sensor()` function can be called at any point in a robot program to zero the force and torque values of the Force Torque Sensor.
- The `get_sensor_Fx()`, `get_sensor_Fy()`, `get_sensor_Fz()`, `get_sensor_Mx()`, `get_sensor_My()`, `get_sensor_Mz()` functions allow the user to assign the sensor values to any variable.
- The `get_applied_tcp_force(<index>)` function returns the current wrench (force and torque vector) value currently applied at the tool center point (TCP).
- The `get_applied_base_force(<index>)` function returns the current wrench (force and torque vector) value applied at the robot arm base.
- The `express_force_in_frame(<T_from_to>,<wrench_from>)` function is used to convert the wrench (force and torque vector) reading in a given reference frame into another (end-effector to robot base, and vice-versa, for example).
  - `T_from_to` = relative pose of the reference frame into which the wrench reading is converted
  - `wrench_from` = wrench to transform in pose or list format (Fx, Fy, Fz, Mx, My, Mz)

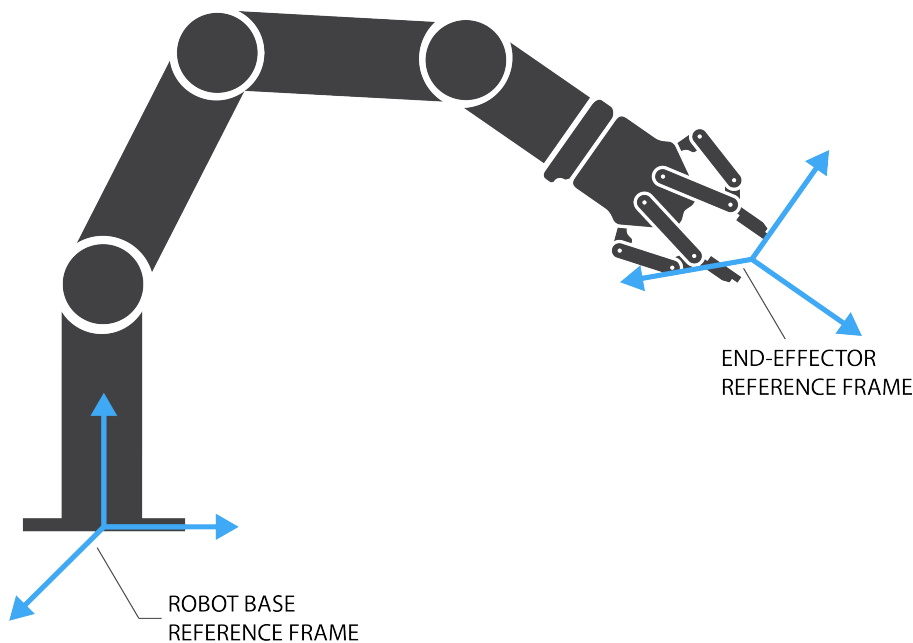

Fig. 4.1: Example of two reference frames for the `express_force_in_frame(<T_from_to>,<wrench_from>)` function

### Info

Although displayed in real time in the Variables tab, the force and torque values can be seen in the Force Copilot Dashboard.

After the calibration has been completed, go to the FT 300 Dashboard to monitor the force and torque values in real time.

Prior to using the FT Sensor's data in the framework of a robot program, it is recommended to zero the sensor using the **Zero sensor button**.



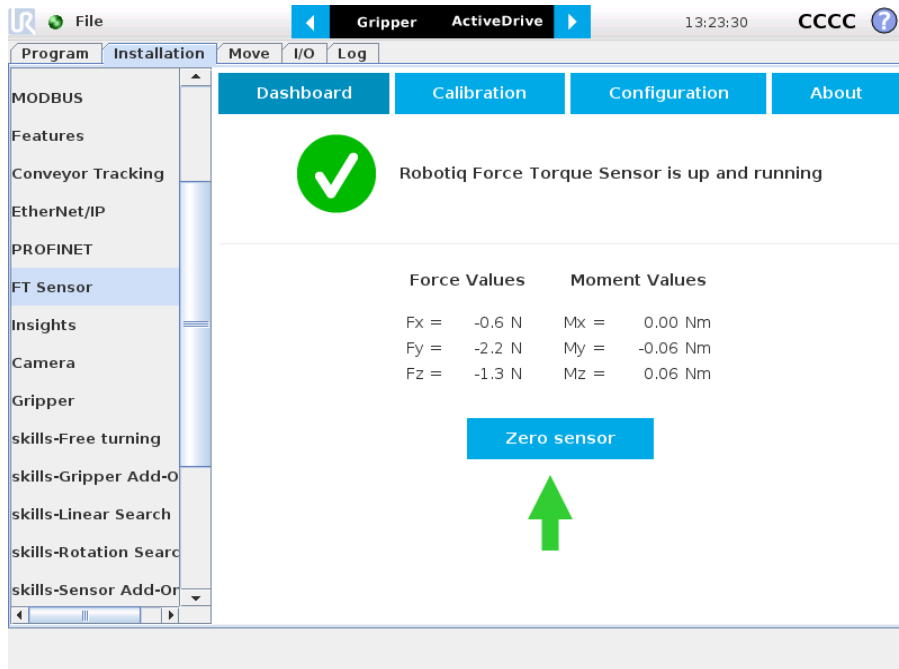

Fig. 4.2: Force Copilot Dashboard with force and torque values displayed in real time.



## 4.1.3. Path Recording

The Force Copilot software package adds a Path feature in PolyScope which can be used to record paths directly by moving the robot. The ActiveDrive Toolbar is a great tool to use while recording a path, as it is an easy way to hand guide the robot's end-effector. Path recording can be used for specific processes requiring complex paths (polishing, gluing, etc.) or more generally for any useful case that would require programming a high number of waypoints. The Path node offers options to modify the recorded path to change its speed and play the path backwards or relative to a variable start position.

### How to add and record a path

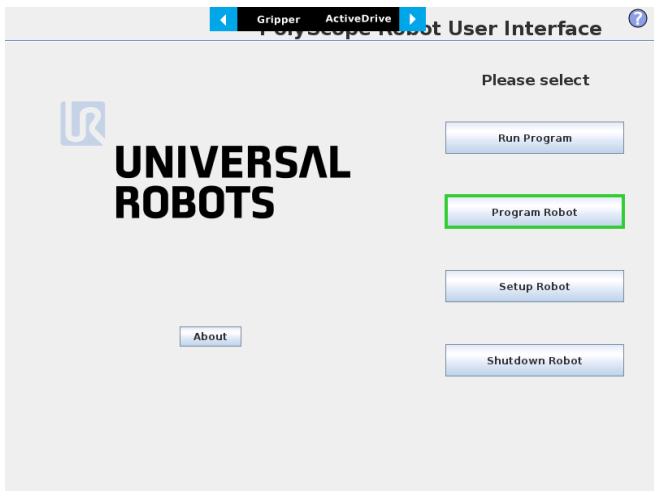
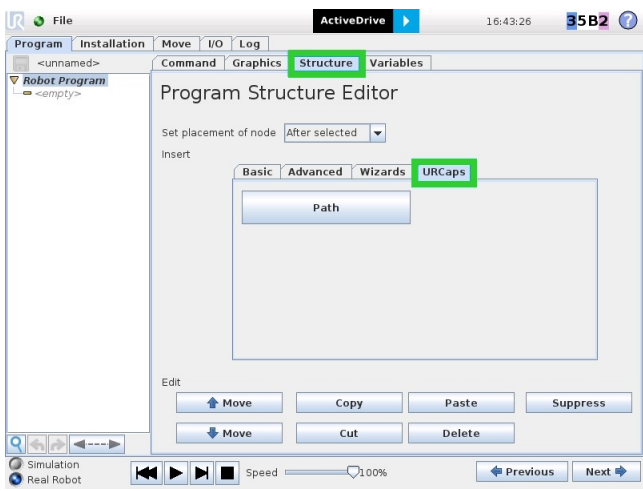
	<ul style="list-style-type: none"> <li>• On the PolyScope home page, tap <b>Program Robot</b></li> <li>• Create an empty program or load an existing program</li> </ul>
	<ul style="list-style-type: none"> <li>• In the <b>Program</b> tab, select the <b>Structure</b> menu.</li> <li>• Select the <b>URCaps</b> sub-menu.</li> <li>• Tap the <b>Path</b> button</li> </ul>



## Overview

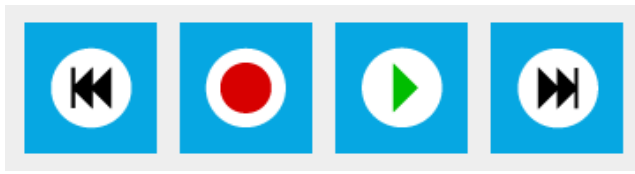

Path recording and visualization.

### Tool Speed

X

Path speed box.



Path options.



**Warning!** Selected options change the speed of the original path recording.

Warning section. Displayed whenever a setting results in a duration different than the original path duration.



## Path



Tool Speed

1.0 X



When a Path node is empty (no path recorded), the only available button is the record button.

## Path



Tool Speed

1.0 X



While recording a path, the only available button is the stop button.

## Path



Tool Speed

0.5 X











 Warning! Selected options change the speed of the original path recording.

When the speed of the original recording is modified using the speed slider, a warning message appears and the path time and speed information is updated.



## Features\*

Primary icon	Description
 	Starts and stops the path recording.
	Press and hold in order to move the robot at the path's start.
	Press and hold in order to move the robot at the path's end.
	Press and hold in order to move the robot to the path's start and play the path as it will be executed in the program.
 <input type="radio"/> <b>Constant speed</b>	If selected, the path is modified to play at a constant tool speed (linear speed at the tool center point). With this option, all pauses and hesitations (dead times) in the path will be removed.
 <input type="radio"/> <b>Reverse path</b>	If selected, the recorded path will be played backwards in the program. It can be useful if a path is copied and played backwards, resulting in a path played back and forth.
 <input type="radio"/> <b>Relative path</b>	<p>If selected, the path will be played relative to the current robot position when the program enters the path instruction.</p> <p>This effectively offsets all the recorded path.</p>
	Displayed whenever a setting results in a duration different than the original path duration.

\* When an icon is greyed, it means it is unavailable.

If you tap the record button when a path is already recorded in a node, a warning pop-up will ask if you want to overwrite the path (tap **OK**) or keep the previously recorded path (tap **Cancel**).



## 4.1.4. Insertion nodes

The Force Copilot software Package includes Insertion nodes, which can be used to perform spiral, rotational and linear movements to insert objects in holes or bores, or to make contact with a surface. It is an essential integration resource for streamlining robot programs in the framework of precise assembly applications.

When the task is performed by a human operator, the operator's fingers provide valuable feedback through the sense of touch, thus allowing the human to detect any resistance when trying to insert a pin in a hole, for instance. To a certain extent, Force Copilot gives that kind of sensitivity to the end effector.

### How to add an Insertion node

- From the PolyScope home page, tap **Program Robot**
- Create or load a robot program
- Go to the **Structure** tab and tap the **URCaps** submenu
- Select **Insertion**
- Tap the **Insertion** node in the robot program to edit it

#### Info

The parent **Insertion** node is automatically followed by a **Zero Sensor** child node.



## Child nodes

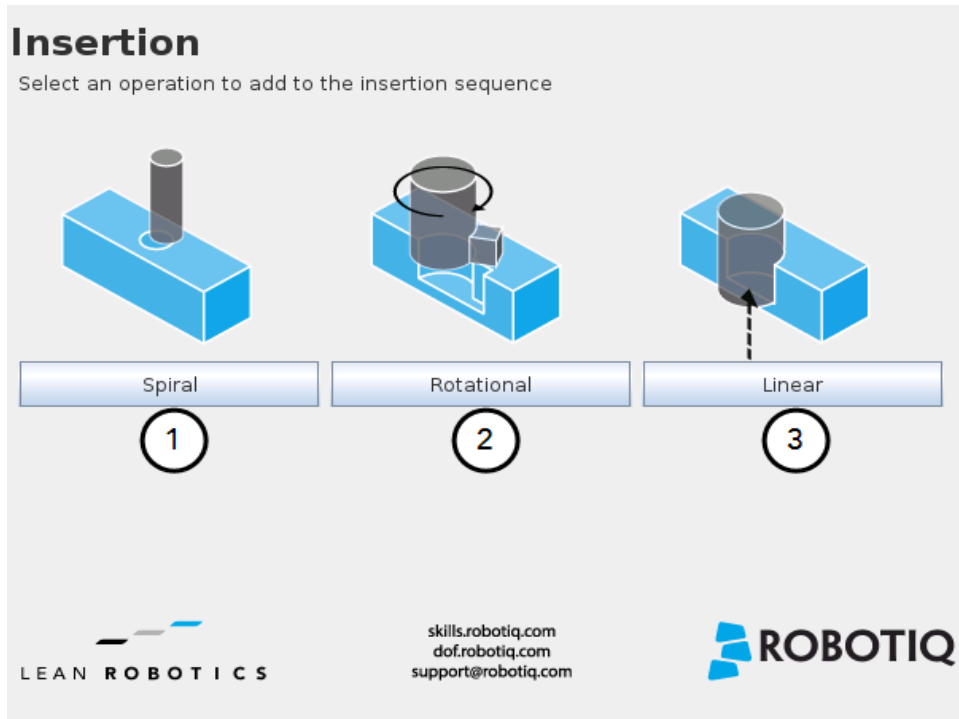

- 1 **Spiral** button to insert a **Spiral** child node
- 2 **Rotational** button to insert a **Rotational** child node
- 3 **Linear** button to insert a **Linear** child node

### Spiral

Following a contact established between the object grasped by the end effector (or the end effector itself) and the corresponding mating part or surface, a spiral motion is engaged on a specific plane to find the path of least resistance according to the direction, speed, force, radius increment per turn and maximum radius parameters set by the user.

### Rotational

Following a contact established between the object grasped by the end effector (or the effector itself) and the corresponding mating part or surface, a rotational motion is engaged on a specific plane to find the path of least resistance, according to the direction, speed, force, maximum torque and maximum rotation angle parameters set by the user.

### Linear

Following the successful spiral, rotational or fortuitous location of a mating hole or bore, a linear motion is engaged at a certain speed until the force threshold or maximum travel distance is reached.



## Features (Spiral)

The Spiral child node is packaged with an **On error** condition line to be populated with a program instruction when/if the error condition occurs. The potential sequence after the Spiral instruction is followed by a program halt, by default.

### Spiral

Function used to insert an object in a hole and to perform a spiral search if an obstacle is found.

Motion

**Destination (A)**

**Direction (B)**

**Advanced parameters**

**Speed (C)**

**Force initiating spiral move (D)**

**Force initiating insertion (G)**

**Radius increment per turn (E)**

**Enable peck mode**

**Tool retraction between points of contact**

Error condition

**Maximum radius (F)**

Teach position

Tool

Z+

5	mm/s
10	N
3	N
0.7	mm

Enable peck mode

5 mm

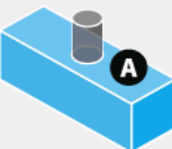

- 1 **Teach position** button (Destination): Tapping this button saves the object's destination as a waypoint in the robot program
- 2 **Reference frame** dropdown menu (Direction): Menu used to select the frame according to which the tool will move in space
- 3 **Axis** dropdown menu (Direction): Menu used to select the direction in which the tool will go to reach the destination
- 4 **Advanced parameters** box: Box that expands the advanced parameters menu when ticked
- 5 **Speed** parameter: Textbox for the user to enter a speed value
- 6 **Force initiating spiral move** parameter: Textbox for the user to enter a force threshold value that triggers the spiral move, after the part/tool has established contact with the mating part/surface
- 7 **Force initiating insertion** parameter: Textbox for the user to enter a force drop value indicating that the part/tool has found the path of least resistance, prior to completing the insertion process
- 8 **Radius increment per turn** parameter: Textbox for the user to enter the distance between each spiral turn on the spiral radius
- 9 **Enable peck mode** box: Box that enables the retraction of the tool between points of contact
- 10 **Maximum radius** (Error condition): Textbox for the user to enter the maximum radius of the spiral, considering that no path of least resistance has been found

### Default values and units of measurement

Parameter	Unit of measurement	Default value
Reference frame (Direction)	N/A	Tool
Axis (Direction)	N/A	Z+
Speed	mm/s	5
Force initiating spiral move	N	10



Parameter	Unit of measurement	Default value
Force initiating insertion	N	3
Radius increment per turn	mm	0.7
Maximum radius (Error condition)	mm	5

## Features (Rotational)

### Rotational

Function used to insert an object in a hole and to rotate on a given tool axis if an obstacle is found.

Motion

**Destination (A)** Teach position 1

**Direction (B)** Tool Z+ 2 Z+ 3

**Advanced parameters** 4

**Linear speed (C)** 5 mm/s 5

**Force initiating rotation (D)** 10 N 6

**Rotation speed** 5 °/s 7

**Maximum torque** 1 Nm 8

**Enable peck mode**

9 **Tool retraction between points of contact**

Error condition

**Maximum rotation angle (E)** 45 ° 10

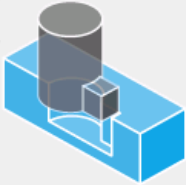

- 1 **Teach position** button (Destination): Tapping this button saves the object's destination as a waypoint in the robot program
- 2 **Reference frame** dropdown menu (Direction): Menu used to select the frame according to which the tool will move in space
- 3 **Axis** dropdown menu (Direction): Menu used to select the direction in which the tool will go to reach the destination
- 4 **Advanced parameters** box: Box that expands the advanced parameters menu when ticked
- 5 **Linear speed** parameter: Textbox for the user to enter a speed value for the approach motion towards the destination
- 6 **Force initiating rotation** parameter: Textbox for the user to enter a force threshold value that triggers the rotation move, after the part/tool has established contact with the mating part/surface
- 7 **Rotation speed** parameter: Textbox for the user to enter a speed value for the rotational (indexing) motion
- 8 **Maximum torque** parameter: Textbox for the user to enter a torque threshold value used to prevent potential collision with objects during the rotational motion
- 9 **Enable peck mode** box: Box that enables the retraction of the tool between points of contact
- 10 **Maximum rotation angle** (Error condition): Textbox for the user to enter the maximum angle of the rotation motion, considering that no path of least resistance has been found



## Default values and units of measurement

Parameter	Unit of measurement	Default value
Reference frame (Direction)	N/A	Tool
Axis (Direction)	N/A	Z+
Linear speed	mm/s	5
Force initiating rotation	N	10
Rotation speed	°/s	5
Maximum torque	Nm	1
Maximum rotation angle (Error condition)	°	45

## Features (Linear)

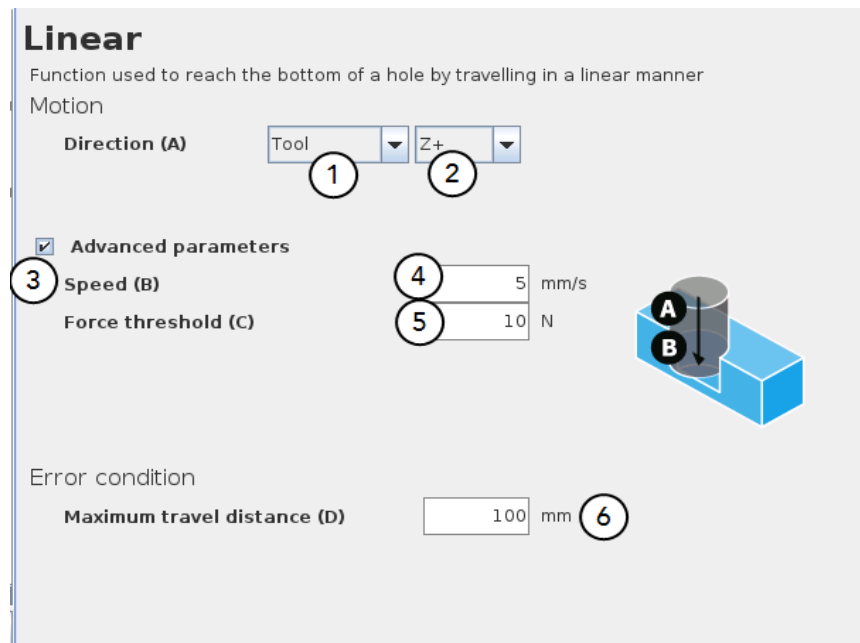

- 1 Reference frame** dropdown menu (Direction): Menu used to select the frame according to which the tool will move in space
- 2 Axis** dropdown menu (Direction): Menu used to select the direction in which the tool will go to reach the destination
- 3 Advanced parameters** box: Box that expands the advanced parameters menu when ticked
- 4 Speed** parameter: Textbox for the user to enter a speed value for the approach motion towards the destination
- 5 Force threshold** parameter: Textbox for the user to enter a force threshold value that completes the linear motion
- 6 Maximum travel distance** (Error condition): Textbox for the user to enter the maximum distance value which, upon being reached, means the force threshold has never been reached in the linear motion

Parameter	Unit of measurement	Default value
Reference frame (Direction)	N/A	Tool
Axis (Direction)	N/A	Z+
Speed	mm/s	5
Force threshold	N	10
Maximum travel distance (Error condition)	mm	100

## 4.1.5. Find Surface node

The Force Copilot software package includes the Find Surface node, which is a great tool for machine tending and various other applications that require repeated accurate positioning of objects.

The default parameters of the function allow for a versatile demo or a quick test of the features while the advanced parameters make it a more customizable asset.

### How to add a Find Surface node

- From the PolyScope home page, tap **Program Robot**
- Create or load a robot program
- Go to the **Structure** tab and tap the **URCaps** submenu
- Select the **Find Surface** node
- Tap the **Find Surface** node in the robot program to edit it

### Find Surface

Use the Force Torque Sensor's data to detect a surface during a robot motion in a given tool axis.

Motion

**Direction relative to the tool (A)** 1 Z+ ▼

2  **Zero Sensor Before Execution**

3  **Advanced parameters**

**Motion speed** 4  mm/s

Stop condition

**Maximum distance traveled (C)** 6  mm

5  Insert a program instruction if this condition occurs.

**Force threshold (B)** 8  N

7  Insert a program instruction if this condition occurs.

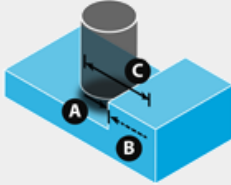

- 1 **Direction relative to the tool** dropdown menu: Menu used to select the direction of the linear motion, relative to the tool
- 2 **Zero Sensor Before Execution** box: Box that inserts a Zero FT Sensor command right before the Find Surface instructions
- 3 **Advanced parameters** box: Box that expands the advanced parameters menu when ticked



- 4 **Motion speed** parameter: Textbox for the user to enter a speed value for the approach motion towards the destination
- 5 **Maximum distance traveled (Stop condition)**: Textbox for the user to enter the maximum distance value which, upon being reached, means the force threshold has never been reached in the linear motion
- 6 **Insert instruction textbox**: Checkbox that inserts the corresponding stop condition in the robot program when ticked; its main function is to facilitate the programming and improve the user experience
- 7 **Force threshold (Stop condition)**: Textbox for the user to enter a force threshold value that completes the linear motion
- 8 **Insert instruction textbox**: Checkbox that inserts the corresponding stop condition in the robot program when ticked; its main function is to facilitate the programming and improve the user experience

Parameter	Unit of measurement	Default value
Direction relative to the tool	N/A	Z+
Motion speed	mm/s	5
Maximum distance traveled (Stop condition)	mm	100
Force threshold (Stop condition)	N	10

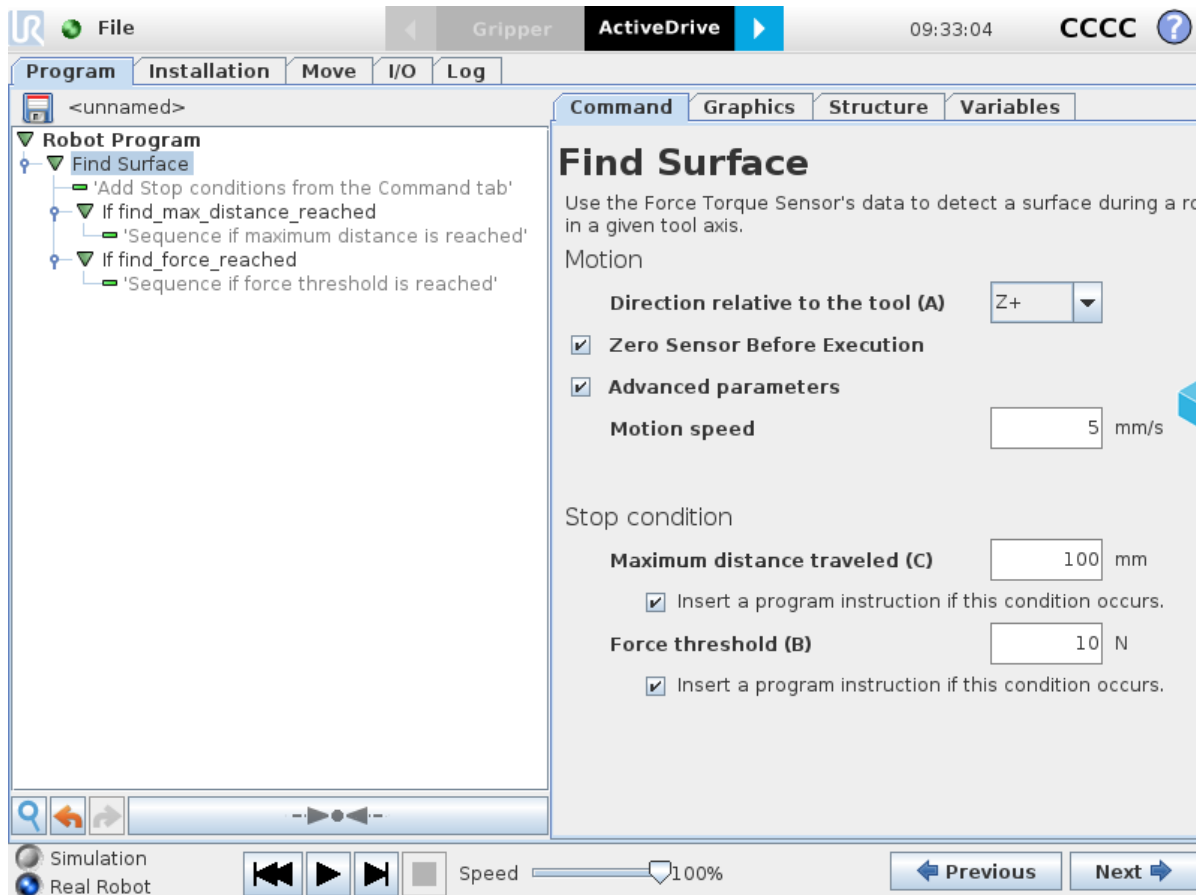



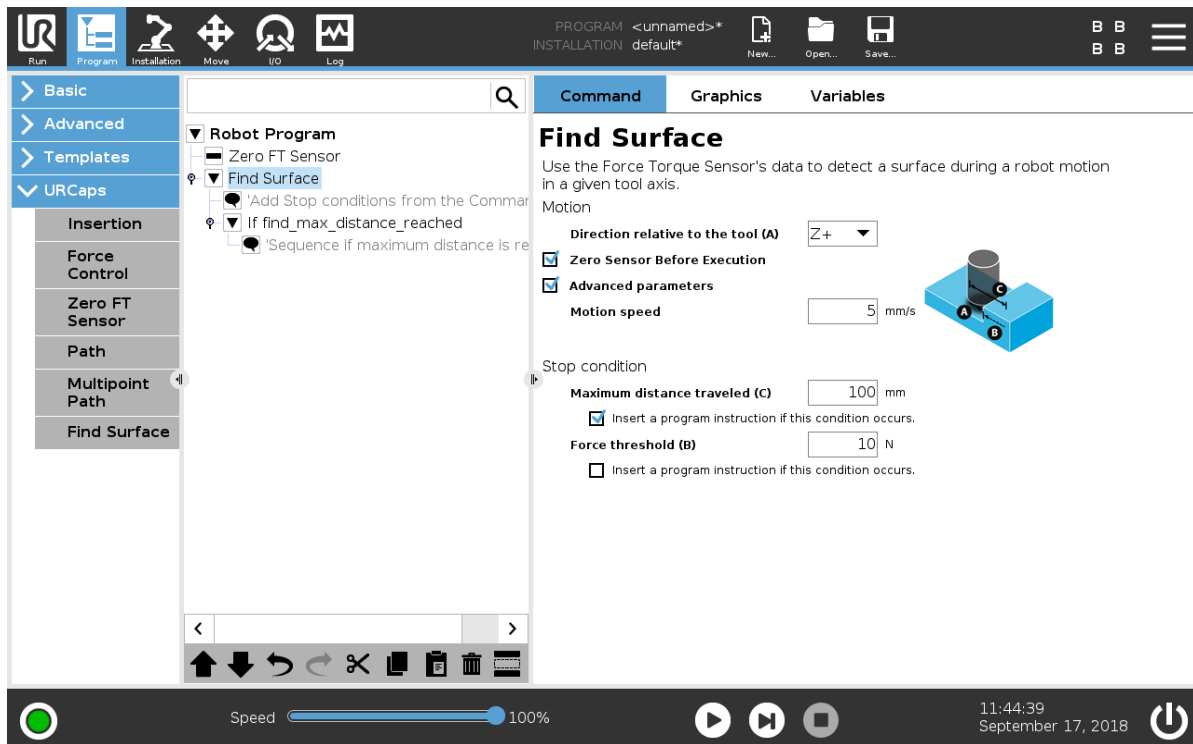
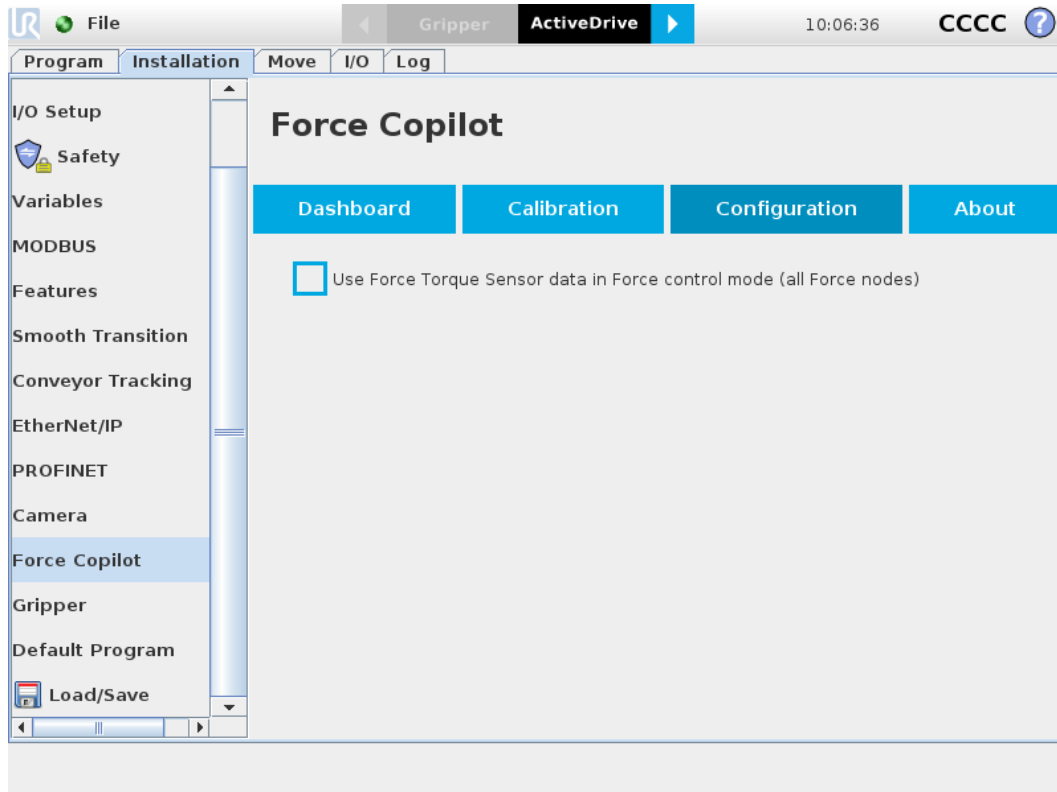

Fig. 4.3: Find Surface node with stop condition(s)



## 4.1.6. Using the Force Torque Sensor's Data in Force Nodes

In order to use the FT Sensor's data in Force control mode for all Force nodes, go to the **Configuration** tab and check the corresponding box. This will feed the Sensor's force values to the UR Force mode as an alternative to UR's embedded force feedback.



## 4.1.7. Force Control Node

### Overview

The Robotiq Force Control node is used to apply force and torque values along and around axes.

#### How to add a Force Control node

- From the PolyScope home page, tap **Program Robot**
- Create or load a robot program
- Go to the **Structure** tab and tap the **URCaps** submenu
- Select the **Force Control** node
- Tap the **Force Control** node in the robot program to edit it

#### Warning

UR Move nodes (MoveL, MoveJ, MoveP) and Force nodes cannot be executed as child of the Robotiq Force Control node.



**Tip**

Where a UR Move node would normally be used, the user shall record a Robotiq Path emulating the desired Move.

In a situation where the user wants to make contact with a surface in accordance with the user-defined settings, a Wait instruction can be inserted as child of the Robotiq Force Control.

The Force Control node is primarily meant to be used with a Robotiq Path node.

With the various user-defined settings available, operators can use a force torque sensor to apply force/torque and thus follow irregular shapes and/or surfaces for applications such as polishing, deburring, finishing, dispensing, etc.



## Features

### Reference frame

The user can select a reference frame from a dropdown menu, as shown below.

The **Tool** reference frame uses the X, Y and Z axes of the **end-effector** to apply force and torque values in the appropriate direction.

On the other hand, the **Base** reference frame takes into consideration the X, Y and Z axes of the **robot arm base**.

## Force Control

Feature Tool ▼

Base

Tool

Test

Enable control	Force/Torque	Stiffness	Deviation range
x <input type="checkbox"/>	Fx <input type="text" value="0"/> N	<input type="text" value="100"/> %	<input type="text" value="-100"/> <input type="text" value="100"/> mm
y <input type="checkbox"/>	Fy <input type="text" value="0"/> N	<input type="text" value="100"/> %	<input type="text" value="-100"/> <input type="text" value="100"/> mm
z <input type="checkbox"/>	Fz <input type="text" value="0"/> N	<input type="text" value="100"/> %	<input type="text" value="-100"/> <input type="text" value="100"/> mm
Rx <input type="checkbox"/>	Mx <input type="text" value="0"/> Nm	<input type="text" value="100"/> %	<input type="text" value="-20"/> <input type="text" value="20"/> °
Ry <input type="checkbox"/>	My <input type="text" value="0"/> Nm	<input type="text" value="100"/> %	<input type="text" value="-20"/> <input type="text" value="20"/> °
Rz <input type="checkbox"/>	Mz <input type="text" value="0"/> Nm	<input type="text" value="100"/> %	<input type="text" value="-20"/> <input type="text" value="20"/> °

**Enable adaptive stiffness**



skills.robotiq.com  
dof.robotiq.com  
support@robotiq.com



Fig. 4.4: Force Control node with Reference Feature dropdown highlighted.

## Parameters

## Force Control

Feature Tool Test

Enable control	Force/Torque	Stiffness	Deviation range
1 x <input checked="" type="checkbox"/>	2 a <input type="text" value="5"/> N	3 <input type="text" value="80"/> %	4 a <input type="text" value="-100"/> <input type="text" value="100"/> mm
y <input type="checkbox"/>	Fy <input type="text" value="0"/> N	<input type="text" value="100"/> %	<input type="text" value="-100"/> <input type="text" value="100"/> mm
z <input type="checkbox"/>	Fz <input type="text" value="0"/> N	<input type="text" value="100"/> %	<input type="text" value="-100"/> <input type="text" value="100"/> mm
Rx <input checked="" type="checkbox"/>	2 b <input type="text" value="10"/> Nm	<input type="text" value="60"/> %	4 b <input type="text" value="-20"/> <input type="text" value="20"/> °
Ry <input type="checkbox"/>	Mx <input type="text" value="0"/> Nm	<input type="text" value="100"/> %	<input type="text" value="-20"/> <input type="text" value="20"/> °
Rz <input type="checkbox"/>	Mz <input type="text" value="0"/> Nm	<input type="text" value="100"/> %	<input type="text" value="-20"/> <input type="text" value="20"/> °

5  Enable adaptive stiffness



LEAN ROBOTICS

skills.robotiq.com  
dof.robotiq.com  
support@robotiq.com



ROBOTIQ

- 1 **Enable control:** each checkbox corresponds to the enablement of force feeding along an axis (upper three options) or torque feeding around an axis (lower three options)
- 2 **Force/Torque:** depending on which options were checked at step 1, the corresponding textboxes here should be filled with the desired force/torque values
  - a Force values applied are in newtons (N) – the range allowed goes from -150 to +150 N
  - b Torque values applied are in newton-metre (Nm) – the range allowed goes from -50 to +50 N.

## Info

Tapping the text boxes brings up a numpad used to enter the values.

- 3 **Stiffness:** the stiffness settings act directly on the Sensor's directional compliance depending on the orientation of the end-effector and the axes selected at step 1.
  - a A stiffness value closer to 0% will provide greater compliance along/around the corresponding axis
  - b A stiffness value of 100% offers no compliance along/around the corresponding axis
- 4 **Deviation range:** the deviation range limits the flexibility allowed along/around the corresponding axis.
  - a The deviation range **along** the X, Y and Z axes is measured in **millimeters (mm)** – the negative range allowed goes from -1000 mm to 0 mm while the positive range allowed goes from 0 mm to 1000 mm.
  - b The deviation range **around** the X, Y and Z axes is measured in **degrees (°)** – the negative range allowed goes from -179° to 0° while the positive range allowed goes from 0° to 179°.

## Example

In a situation where **10 N** are applied exclusively along the **Z-axis**, with **20% stiffness** along the X and Y axes, and a deviation range that goes from **-50 mm to +50 mm** along all axes...



- The end-effector will systematically point towards its Z-axis
- The end-effector will not rotate around Rx, Ry and Rz (no torque feeding)
- The end-effector will be moderately flexible to move along the X and Y axes
- The movements along the X, Y and Z axes will be limited to -50 mm and +50 mm from the command position

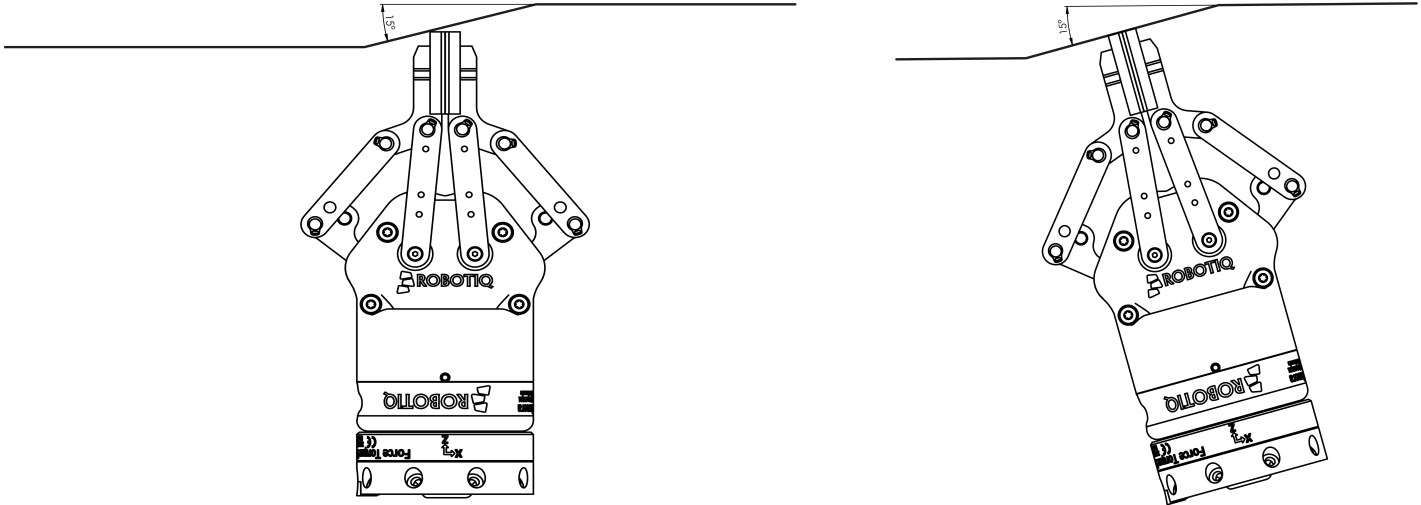

Fig. 4.5: Deviation range - On the left, no deviation range has been entered. On the right, a deviation range of at least 15 degrees has been entered around the corresponding axis.

- 5 Enable adaptive stiffness:** this checkbox greys out the stiffness values in the boxes at step 3 since the Force Control calculates the rigidity of the surface/object with which the end-effector comes in contact. Thus, constant force/torque values are applied to surfaces with variable rigidity (e.g.: long, bent, bending or folded sheets or parts).

When entering into contact with a surface for the first time, the end-effector will pull back for it has reached the force/torque value entered at steps 2a and/or 2b. It will then go back to the surface and apply the same force/torque values while pulling back less and less over time.

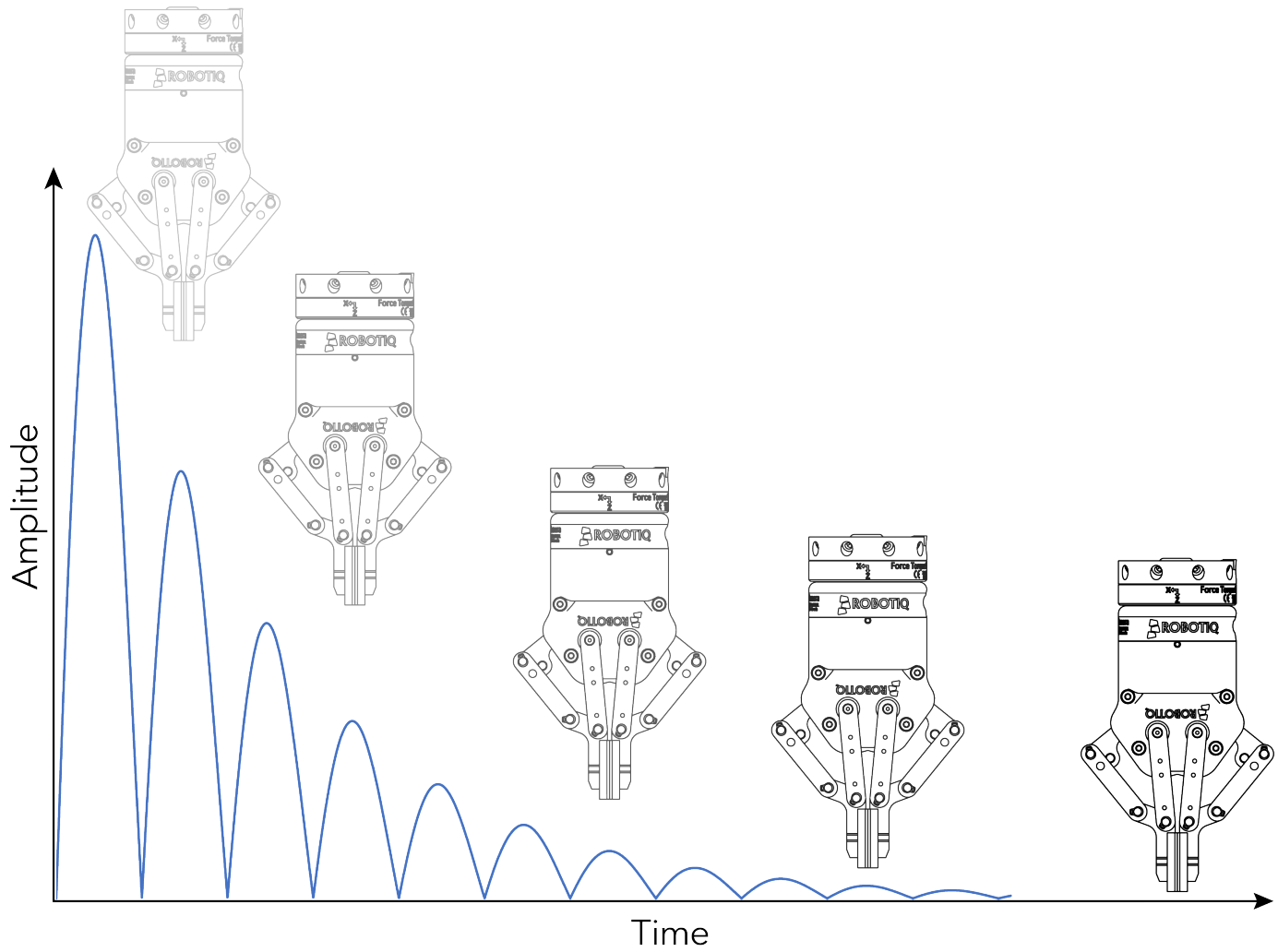

Fig. 4.6: End-effector experiencing adaptive stiffness upon repeated contact with a surface

## Test

The Test button applies the user-defined settings of the Force Control node to the sensor, therefore moving along/around the corresponding axes, if the control had been enabled for the latter, regardless of other instructions entered before or after the Force Control node in the program tree.

## Force Control

Feature

**Test**

Enable control	Force/Torque	Stiffness	Deviation range
x <input checked="" type="checkbox"/>	Fx <input type="text" value="5"/> N	<input type="text" value="80"/> %	<input type="text" value="-100"/> <input type="text" value="100"/> mm
y <input type="checkbox"/>	Fy <input type="text" value="0"/> N	<input type="text" value="100"/> %	<input type="text" value="-100"/> <input type="text" value="100"/> mm
z <input type="checkbox"/>	Fz <input type="text" value="0"/> N	<input type="text" value="100"/> %	<input type="text" value="-100"/> <input type="text" value="100"/> mm
Rx <input checked="" type="checkbox"/>	Mx <input type="text" value="10"/> Nm	<input type="text" value="60"/> %	<input type="text" value="-20"/> <input type="text" value="20"/> °
Ry <input type="checkbox"/>	My <input type="text" value="0"/> Nm	<input type="text" value="100"/> %	<input type="text" value="-20"/> <input type="text" value="20"/> °
Rz <input type="checkbox"/>	Mz <input type="text" value="0"/> Nm	<input type="text" value="100"/> %	<input type="text" value="-20"/> <input type="text" value="20"/> °

Enable adaptive stiffness



skills.robotiq.com  
dof.robotiq.com  
support@robotiq.com





## 4.1.8. Multipoint Path Node

The Multipoint Path node is an advanced version of the Path node, combining complex trajectory recording and point-to-point teaching, with the option to define each segment as a **straight line** or as a **curve**.

### Tip

Try inserting a Multipoint Path node in a Robotiq Force Control node. The former will perform the movements that were taught while taking into consideration the parameters set in the latter.

### How to add a Multipoint Path node

- From the PolyScope home page, tap **Program Robot**
- Create or load a robot program
- Go to the **Structure** tab and tap the **URCaps** submenu
- Select the **Multipoint Path** node
- Tap the **Force Control** node in the robot program to edit it

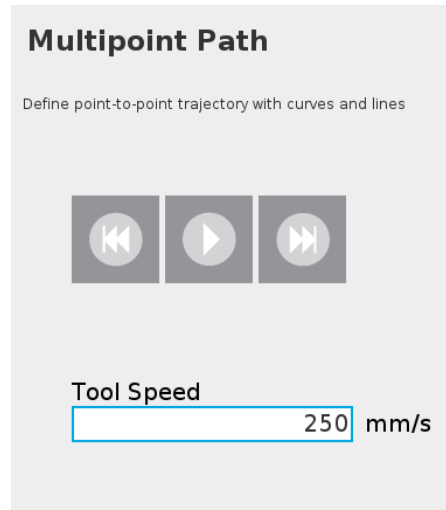
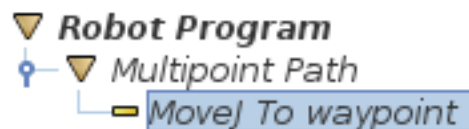

Fig. 4.7: Multipoint Path node (empty)

### Info

Please note that a Multipoint Path parent node is **always** followed by a MoveJ command leading to the starting waypoint of the path sequence.



## How to set up a Multipoint Path

### Step 1

- Select the **MoveJ To waypoint** child node in the program tree.
- A menu will display in the **Command** tab.
- Using the Freedrive mode or the UR Move menu, move the robot arm to the position you want to be the starting point of your Multipoint Path.

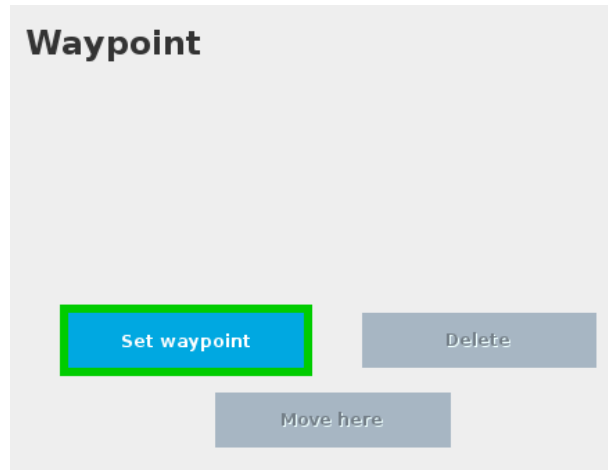

- Tap the **Set waypoint** button. The UR waypoint interface will pop up and ask you to define the waypoint.
- Adjust the position if needed, then press OK.

At this point, the interface will look like this:

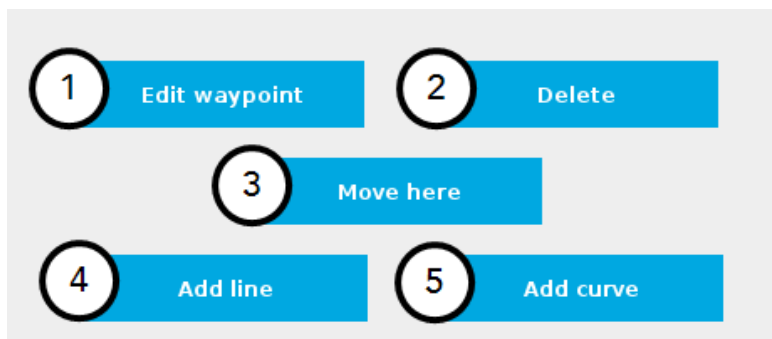

- 1 Tap the **Edit** button to open the UR waypoint interface and adjust the position of the robot arm (this works for every waypoint of the Multipoint Path)
- 2 Tap the **Delete** button to cancel the waypoint (deleting the starting waypoint will turn it to unassigned)
- 3 Tap and hold the **Move here** button to make the robot arm travel to the corresponding waypoint
- 4 Tap the **Add line** button to let the system know that a **straight line** will be linking the current waypoint and the next waypoint
- 5 Tap the **Add curve** button to let the system know that a **curve** will be linking the current waypoint and the next waypoint

#### Important

Whether the path is made of straight lines, curves or a mix of both, it inevitably passes through each waypoint set by the user.



### Important

The curve segments are not generated and/or represented according to a spline model; they are rather based on **Bézier curves**.

### Info

For describing the continuity of the curves used in the Multipoint Path node, control points are generated on the bisector of each waypoint junction (angle). Curves are therefore tangent to those bisectors.

## Step 2

- Using the Freedrive mode or the UR Move menu, move the robot arm to the next desired position.
- Add another waypoint in the program tree by tapping the **Add line** or **Add curve** button.

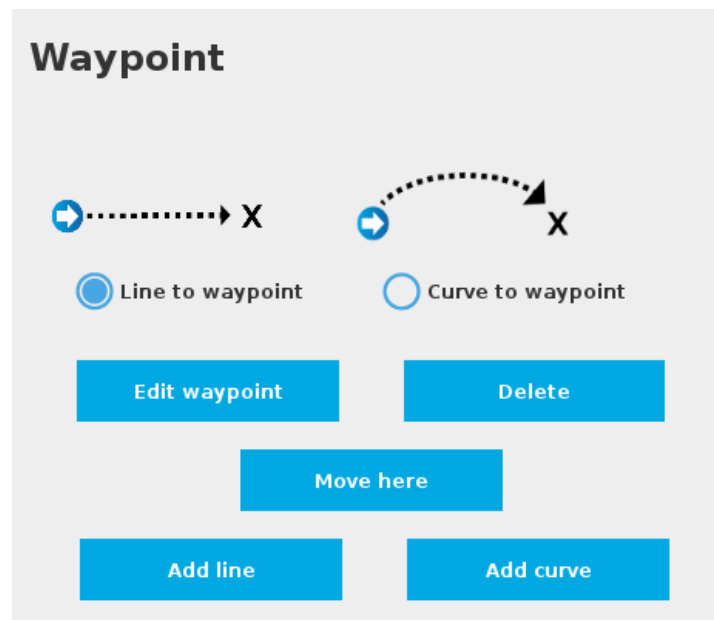

Fig. 4.8: Multipoint Path interface with Line/Curve options.



**Caution**

Adding several waypoints (lines or curves) without moving the robot in between them will result in the generation of identical waypoints.

In order to remedy this situation, the user can edit each waypoint created and adjust its position.

**Tip**

You can toggle at any time between the **Line to waypoint** and **Curve to waypoint** options.

Select the waypoint in the program tree and tap the appropriate radio button in the **Command** tab.

Repeat step 2 until you complete your Multipoint Path.

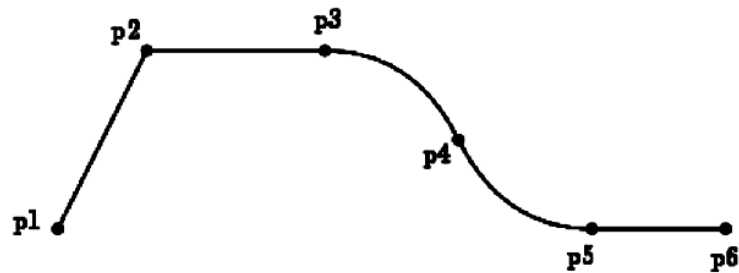

Fig. 4.9: Representation of a six-waypoint Multipoint Path with both curves and straight lines.

## 4.2. Development Package

The Robotiq Force Torque Sensor development package can be downloaded at [support.robotiq.com](http://support.robotiq.com).

### 4.2.1. Distribution License

The development package is distributed under the New BSD license, which is a permissive free software license. In short, the provided code can be used in any project without any restriction regarding its use (commercial or not). If it is included in a software, this software does not need to be open-source. However, the code is provided "as is" without any liability from Robotiq and some restrictions apply regarding the distribution of the code and the use of the Robotiq name.

The terms of the license (included in each source file) are described here:

```
Software License Agreement (BSD License)
```

```
Copyright (c) 2014, Robotiq, Inc. All rights reserved.
```

```
Redistribution and use in source and binary forms, with or
without
modification, are permitted provided that the following con-
ditions are met:
```

- Redistributions of source code must retain the above copyright notice, this list of conditions and the following disclaimer.
- Redistributions in binary form must reproduce the above copyright notice, this list of conditions and the following disclaimer in the documentation and/or other materials provided with the distribution.
- Neither the name of Robotiq, Inc. nor the names of its contributors may be used to endorse or promote products derived from this software without specific prior written permission.

```
THIS SOFTWARE IS PROVIDED BY THE COPYRIGHT HOLDERS AND
CONTRIBUTORS
```

```
"AS IS" AND ANY EXPRESS OR IMPLIED WARRANTIES, INCLUDING, BUT NOT
LIMITED TO, THE IMPLIED WARRANTIES OF MERCHANTABILITY AND FITNESS
FOR A PARTICULAR PURPOSE ARE DISCLAIMED. IN NO EVENT SHALL THE
COPYRIGHT OWNER OR CONTRIBUTORS BE LIABLE FOR ANY DIRECT,
INDIRECT,
INCIDENTAL, SPECIAL, EXEMPLARY, OR CONSEQUENTIAL DAMAGES
(INCLUDING,
BUT NOT LIMITED TO, PROCUREMENT OF SUBSTITUTE GOODS OR SERVICES;
LOSS OF USE, DATA, OR PROFITS; OR BUSINESS INTERRUPTION) HOWEVER
CAUSED AND ON ANY THEORY OF LIABILITY, WHETHER IN CONTRACT,
```



STRICT  
LIABILITY, OR TORT (INCLUDING NEGLIGENCE OR OTHERWISE) ARISING IN  
ANY WAY OUT OF THE USE OF THIS SOFTWARE, EVEN IF ADVISED OF THE  
POSSIBILITY OF SUCH DAMAGE.



## 4.2.2. Linux

### Package Files – Description

The development package is structured with the following files and directories architecture (non-Linux files and directories are ignored in this section):

- src: contains the source files common to all platforms
- obj: used during compilation for the object files related to the common sources
- Linux: contains Linux specific files
  - bin: contains the binary files
  - src: contains the source files common to all platforms
    - main.c : application source file which can be modified by the user
  - obj: contains all the object files after they are compiled
- Makefile: file containing the rules to compile the sensor driver using Make

#### Caution

When started, the provided software will scan all ports in the system (ttySx and ttyUSBx) to find a compatible Robotiq device. It uses the Linux utility "fuser" to determine if the port is already opened. This section of code can be modified by the user if necessary to avoid the scanning of ports (for example, if another device would become confused when receiving a message that it cannot understand).

### Procedure to Compile and Test the Provided Source Code

This procedure explains how to compile the source code and verify that the sensor data is properly read.

1. Unzip the package in the home folder, for example in the folder ~/driver/
2. Open a terminal and enter the package directory using the following command:

```
rd@debian:~/ $ cd driver
```

3. Use Make to compile the application:

```
rd@debian:~/ $ make linux
```

4. In order to have access to the virtual serial COM port, add the used username to the group dialout:

```
rd@debian:~/ $ sudo usermod -a -G dialout username
```

5. It is required to log out (or reboot) the session in order for the group change to become effective.



6. Make sure that the sensor is properly powered and that the data signals are connected to the development PC using the provided RS485 to USB converter. A new device named `ttyUSBx` should be present in `/dev`, which can be verified with the following command:

```
rd@debian:~/ $ ls -l /dev | grep ttyUSB
```

7. In a terminal, go to the `~/driver/Linux/bin` folder and execute the demo application using the following command:

```
rd@debian:~/driver/Linux/bin/ $ ./driverSensor
```

8. After 1-2 seconds, the sensor data should start showing up in the terminal as a vector of 6 floats with data in the (Fx, Fy, Fz, Mx, My, Mz) format.

```
rd@rd-VirtualBox: ~/driver/Linux/bin
rd@rd-VirtualBox:~/driver/Linux/bin$ ./driverSensor
( 1.300000 , -1.620000 , 1.650000 , -0.034000 , -0.080000 , -0.120000 )
( 1.300000 , -1.620000 , 1.650000 , -0.034000 , -0.080000 , -0.120000 )
( 1.300000 , -1.620000 , 1.650000 , -0.034000 , -0.080000 , -0.120000 )
( 1.890000 , -0.730000 , 1.580000 , -0.039000 , -0.083000 , -0.146000 )
( 1.890000 , -0.730000 , 1.580000 , -0.039000 , -0.083000 , -0.146000 )
( 2.190000 , -0.840000 , 1.720000 , -0.045000 , -0.074000 , -0.139000 )
( 2.190000 , -0.840000 , 1.720000 , -0.045000 , -0.074000 , -0.139000 )
```

Fig. 4.10: Sensor Data Acquisition.

## Adapt to a User Application

In practice, the provided source code will be adapted to either: be incorporated with a custom application or to communicate with one. At this point, the `main.c` file should be adapted according to the guideline comments inserted in the code.

### Caution

Please note that Robotiq can only support our customers in making sure they can compile and test the provided code as is.

No support can be provided for the integration of the provided source code into a custom application.



## 4.2.3. Windows

### Package Files – Description

The development package is structured with the following files and directories architecture (non-Windows files and directories are ignored in this section):

- src: contains the source files common to all platforms
- obj: used during compilation for the object files related to the common sources
- Windows: contains Windows specific files
  - bin: contains the binary files
  - src: contains the source files common to all platforms
    - main.c : application source file which can be modified by the user
  - obj: contains all object files after they are compiled
  - Data\_logger: contains an application (and its source code) to log data from the sensor
  - compiler.bat: script which automates the settings for the environment variables and the compilation of the example application
- Makefile: file containing the rules to compile the sensor driver using Make

### Procedure to Compile and Test the Provided Source Code

This procedure explains how to install MinGW, compile the provided source code and verify that the sensor data is properly read.

1. Unzip the package in the desired directory.
2. If it is not already installed, download MinGW at <http://www.mingw.org/>. Download the installer "mingw-get-setup.exe".
3. Install MinGW by running "mingw-get-setup.exe" and save the default installation path.
4. Open "MinGW installation manager".
5. Select "mingw-developer-toolkit" in the "Basic setup" tab and click "Mark for Installation".
6. Select "mingw32-binutils" in the "All packages" tab and click "Mark for Installation".
7. In the menu "Installation", click "Apply changes". This will install the required packages to compose the software using Make.
8. In the Windows directory, run the compiler.bat file. This will build your application.
9. Run the application "driverSensor" located in the "Windows/bin/" folder.
10. After 1-2 seconds, the sensor data should start showing up in the command window as a vector of 6 floats with data in the (Fx, Fy, Fz, Mx, My, Mz) format.

```

C:\Users\rd\Desktop\driver\Windows\bin\driverSensor.exe
< 1.760000 , -2.690000 , 0.650000 , 0.044000 , -0.031000 , -0.156000 >
< 1.760000 , -2.690000 , 0.650000 , 0.044000 , -0.031000 , -0.156000 >
< 1.740000 , -2.630000 , 0.580000 , 0.040000 , -0.034000 , -0.174000 >
< 1.740000 , -2.630000 , 0.580000 , 0.040000 , -0.034000 , -0.174000 >
< 2.080000 , -2.910000 , 0.950000 , 0.043000 , -0.032000 , -0.167000 >
< 1.490000 , -2.550000 , 0.870000 , 0.046000 , -0.036000 , -0.164000 >
< 1.490000 , -2.550000 , 0.870000 , 0.046000 , -0.036000 , -0.164000 >
< 1.160000 , -3.070000 , 0.570000 , 0.041000 , -0.027000 , -0.164000 >
< 1.160000 , -3.070000 , 0.570000 , 0.041000 , -0.027000 , -0.164000 >
< 1.540000 , -2.870000 , 0.860000 , 0.043000 , -0.011000 , -0.173000 >

```

Fig. 4.11: Sensor Data Acquisition Under Windows.



## Adapt to a User Application

In practice, the provided source code will be adapted to either: be incorporated with a custom application or to communicate with one. At this point, the main.c file should be adapted according to the suggested comments inserted in the code.

### Caution

Please note that Robotiq can only support our customers in making sure they can compile and test the provided code as is.

No support can be provided for the integration of the provided source code into a custom application.



## 4.3. Visual Demo Software

The Visual Demo Software is used to demonstrate the ability of the FT Sensor to read force and moment. It is not intended to be used for programming or to save or use data. It can also be used to calibrate the Sensor. Please refer to the **Calibration Procedure for the Visual Demo Software (PC)** section for the calibration procedure.

### 4.3.1. Software Package Installation

- 1 Make sure that you have the latest version of the Visual Demo Software, which can be found at [support.robotiq.com](http://support.robotiq.com).

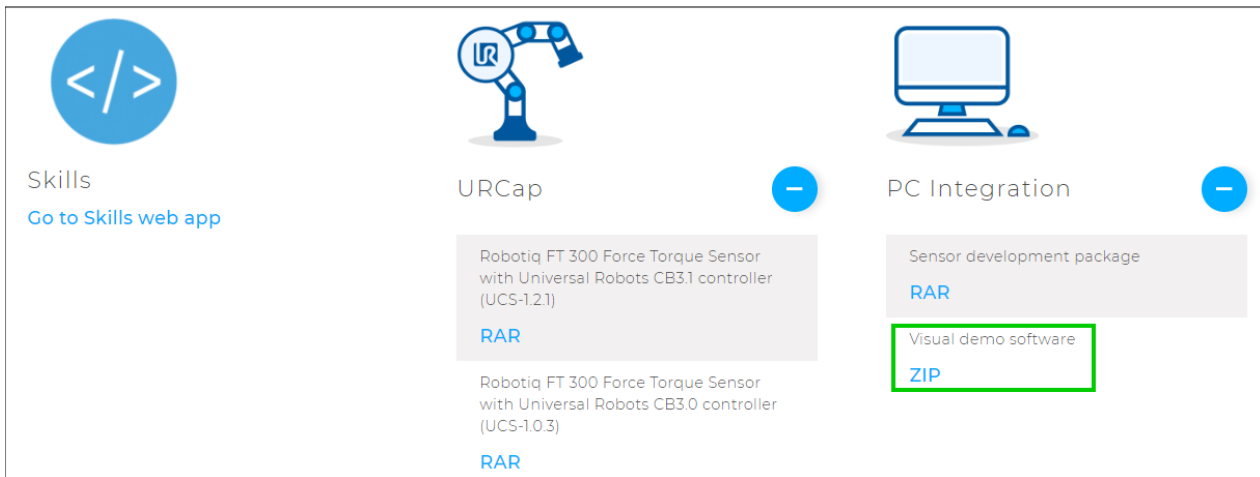

The screenshot shows a software installation interface with three main sections:

- Skills**: Includes a code icon and a link to "Go to Skills web app".
- URCap**: Contains two entries for "Robotiq FT 300 Force Torque Sensor with Universal Robots CB3.1 controller (UCS-1.2.1)" and "Robotiq FT 300 Force Torque Sensor with Universal Robots CB3.0 controller (UCS-1.0.3)", both with "RAR" download options.
- PC Integration**: Contains a "Sensor development package" section with "RAR" and "Visual demo software" (highlighted with a green box) and "ZIP" download options.

- 2 Copy all the files of this folder onto a PC.
- 3 Connect the USB connector to the converter attached to the PC. Important : The Sensor must NOT be powered at this time.
- 4 Wait while the driver(s) install. After all the drivers have been installed.
- 5 Plug the Sensor cable into the Sensor.
- 6 Connect the Sensor cable to the power supply.
- 7 Launch the demo application.

File Name	Date Modified	Type	Size
instructions	2014-09-19 4:41 PM	Text Document	1 KB
libgcc_s_dw2-1.dll	2009-06-22 3:42 PM	Application extens...	42 KB
libstdc++-6.dll	2011-12-01 7:30 PM	Application extens...	958 KB
mingwm10.dll	2009-01-10 1:32 PM	Application extens...	12 KB
QtCore4.dll	2014-01-13 3:11 PM	Application extens...	2,479 KB
QtGui4.dll	2010-09-10 8:32 AM	Application extens...	9,632 KB
QtNetwork4.dll	2010-09-10 8:07 AM	Application extens...	1,114 KB
<input checked="" type="checkbox"/> robotiq_FT_sensor_demo	2016-02-17 12:01 ...	Application	937 KB



- 8 You should see a **COM** port in green with a serial number, showing the Sensor connected to the PC. Click on it.

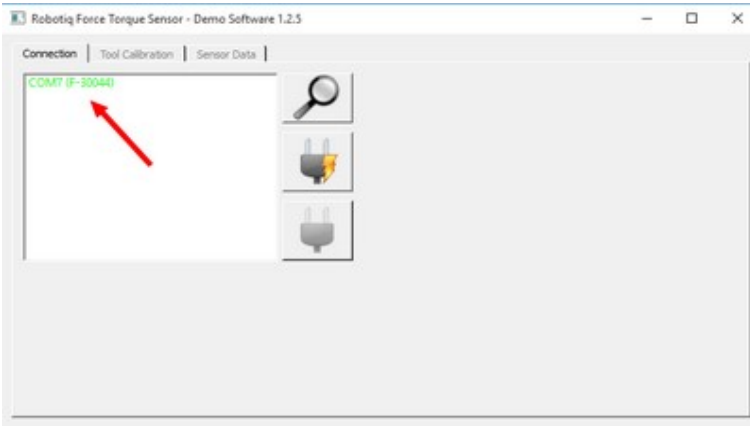

By going into the **Sensor Data** tab, you can now see in real time the force and moment applied on the FT Sensor.

## 4.4. Serial Communication

The FT Sensor uses two communication modes, Modbus RTU and data stream. The Modbus RTU communication mode is used to obtain information on the Sensor, like its firmware version. The data stream mode is used to obtain data from the Sensor.

### Info

It is recommended to use the FT Sensor data stream to obtain faster data acquisition.

### Caution

Modbus RTU can be used to obtain data, but will result in a slower data acquisition frequency.

### Info

In both modes, force and torque data from the Sensor will be in 16-bits signed integer format.

### 4.4.1. Modbus RTU

The FT Sensor can be controlled over USB using an ACC-ADT-USB-RS485 signal converter. This section is intended to provide guidelines for setting up a Modbus scanner that will adequately communicate with the Sensor.

For a general introduction to Modbus RTU and for details regarding the CRC algorithm, the reader is invited to read the Modbus over serial line specification and implementation guide available at: [http://www.modbus.org/docs/Modbus\\_over\\_serial\\_line\\_V1\\_02.pdf](http://www.modbus.org/docs/Modbus_over_serial_line_V1_02.pdf).

For debugging purposes, the reader is also invited to download one of many free Modbus scanners such as the *CAS Modbus Scanner* from Chipkin Automation Systems available at: <http://www.store.chipkin.com/products/tools/cas-modbus-scanner>.

### Info

Modbus RTU is a communication protocol based on Big Endian byte order. Therefore, the 16-bit register addresses are transmitted with the most significant byte first. However, the data port is, in the case of Robotiq products, based on the Little Endian byte order. As such, the data parts of Modbus RTU messages are sent with the less significant byte first.

### Tip

Modbus RTU specification and details can be found at [www.modbus.org](http://www.modbus.org)



## Connection Setup

The following table describes the connection requirements for controlling the Sensor using the Modbus RTU protocol:

Propriety	Value
Baudrate (bps)	19,200
Data bits	8
Stop bit	1
Parity	None
Supported Functions	Read Holding Register (FC03) Preset Multiple Register (FC16)
Slave ID	0x0009 (9)

In Modbus RTU you can obtain the following information:

Information	Register
Production year-	514
Serial number	510 to 513
Force X (N) = value / 100	180
Force Y (N) = value / 100	181
Force Z (N) = value / 100	182
Moment X (Nm) = value / 1000	183
Moment Y(Nm) = value / 1000	184
Moment Z (Nm) = value / 1000	185
Acceleration X (g) = value / 1000	190



Information	Register
Acceleration Y (g) = value / 1000	191
Acceleration Z (g) = value / 1000	192



## Read Holding Register (FC03)

Function code 03 (FC03) is used to read the status of the Sensor (robot input). Examples of such data is the display of the current force and torque values.

Example of FC03 Read Function:

To get Fx, you need to read (03) the register 180 (00B4) in device ID 9 (09).

Request is: 09 03 00 B4 00 01 C5 64

Hex format: 0x09 0x03 0x00 0xB4 0x00 0x01 0xC5 0x64

Bits	Description
09	SlaveID
03	Function Code 03 (Read Holding Register)
00B4	Address of the first requested register
0001	Number of registers requested (1)
C564	Cycle Redundancy Check (CRC)

To get all 6 force/torque values at once, you need to read (03) six registers (0006), starting with register 180 (00B4) in device ID 9 (09).

Request is: 09 03 00 B4 00 06 04 A6

Hex format: 0x09 0x03 0x00 0xB4 0x00 0x06 0x84 0xA6

Bits	Description
09	SlaveID
03	Function Code 03 (Read Holding Register)
00B4	Address of the first requested register
0006	Number of registers requested (6)
04A6	Cycle Redundancy Check (CRC)





## 4.4.2. Data Stream

Data stream mode is the recommended method of obtaining data from the Sensor. Once initiated, the Sensor will stream force and moment data continuously until communication is interrupted by the user.

### Tip

To start the data stream, write 0x0200 in register 410.

For a setup over Universal Robots, Data stream will be accessible on TCP port 63351 of your machine.

### Tip

With a Universal Robot, you can access the data stream using the documentation available at UR : Remote Control Via TCP/IP - 16496

To stop the data stream, communication must be interrupted by sending a series of 0xff characters to the Sensor. Sending for about 0.5s (50 times) will ensure that the Sensor stops the stream.

When the stream is started, 16 bytes messages are sent by the sensor at 100Hz using this format:

`<0x20><0x4e><LSB_data1><MSB_data1> ... <LSB_data6><MSB_data6><LSB_crc><MSB_crc>`

With dataX being a 16-bits signed integer defined as:

Data	Value meaning
data1	$F_x * 100$ (N)
data2	$F_y * 100$ (N)
data3	$F_z * 100$ (N)
data4	$M_x * 1000$ (Nm)
data5	$M_y * 1000$ (Nm)
data6	$M_z * 1000$ (Nm)

The CRC is computed using a standard 16-bits modbus CRC (see [http://www.ccontrols.com/w/How\\_to\\_Compute\\_the\\_Modbus\\_RTU\\_Message\\_CRC](http://www.ccontrols.com/w/How_to_Compute_the_Modbus_RTU_Message_CRC)).

## Preset Multiple Registers (FC16)

Function code 16 (FC16) is used to activate functionalities of the Gripper (robot output). A common example is the initialization of data streaming.

Example of setting multiple registers (FC16):

To initialize the data stream, 0x0200 must be written with the function 16 (0x10) in register 410 (019A).



Request is: 09 10 01 9A 00 01 02 02 00 CD CA

Hex format: 0x09 0x10 0x01 0x9A 0x00 0x01 0x02 0x02 0x00 0xCD 0xCA

Bits	Description
09	SlaveID
10	Function Code 16 (Preset Multiple Registers)
019A	Address of the first register
0001	Number of registers requested (1)
02	Number of data bytes to follow (1 registers x 2 bytes/register = 2 bytes)
0200	Value written to register 0x019A
CDCA	Cycle Redundancy Check (CRC)



## 5. Specifications

The following sections provide data on the various specifications of the Robotiq Force Torque Sensor.

- Section 5.1 details the technical dimensions of the sensor.
- Section 5.2 details the mechanical specifications.
- Section 5.3 covers signal specifications (data acquisition).
- Section 5.4 specifies electrical rating.
- Section 5.5 covers the technical dimensions of the sensor coupling options.

### 5.1. Technical Dimensions

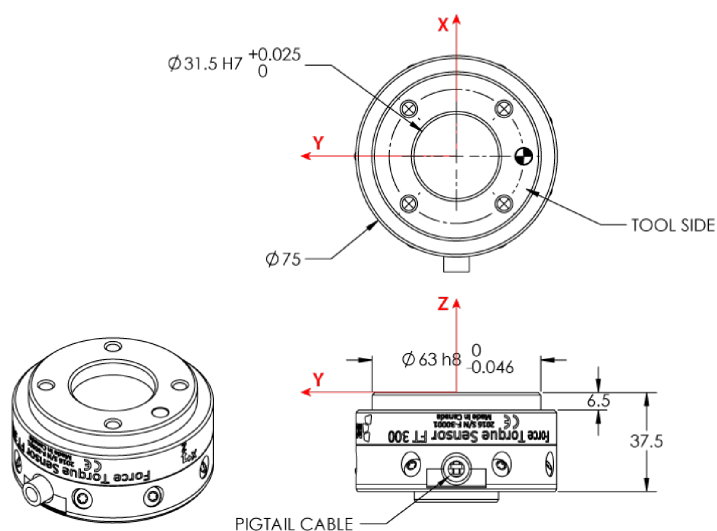

Fig. 5.1: Robotiq FT 300 Sensor general technical dimensions.

#### Info

Reminder: Measures are in millimeters.



## 5.1.1. Tool Side Bolt Pattern

The figure below illustrates the bolt pattern used for tool fixation on the FT 300 Sensor.

- Bolt pattern diameter is 50 mm
- Mounting holes are M6 thread, 6 mm deep.
- Indexing hole for M6 dowel pin has a tight fit (H7) and 6 mm deep.
- Outside diameter of the flange is 64 mm and inside is 45 mm.

### Info

FT 300 tool side bolt pattern matches ISO-9409-1-50-4M6.

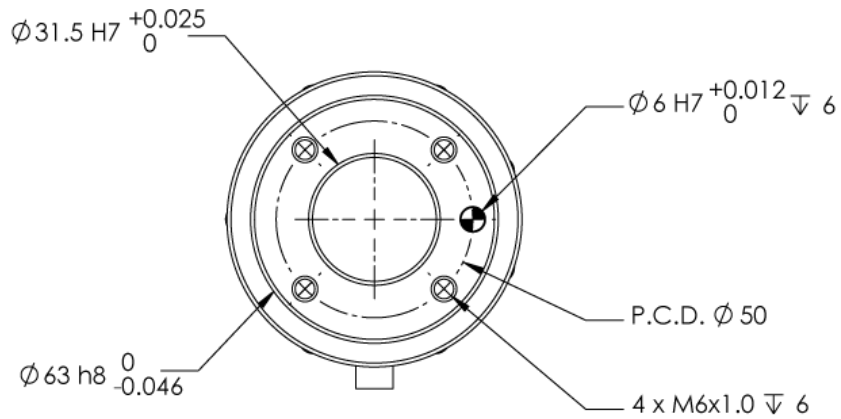

Fig. 5.2: FT 300 Sensor tool side bolt pattern.



## 5.2. Mechanical Specifications

### Info

Reminder: all units are within the metric measurement system.

SPECIFICATION		VALUE
Approximate weight		300 g
Overload capacity		A combined load exceeding 500% of the measuring range will permanently damage the Force Torque Sensor ( $F_x/300 + F_y/300 + F_z/300 + M_x/30 + M_y/30 + M_z/30 < 500\%$ )
Outside diameter		75 mm
Through-hole diameter		N/A
Thickness		37.5 mm
IP rating		43 <sup>1</sup>
Stiffness	$F_x, F_y$	$35 \times 10^6$ N/m
	$F_z$	$30 \times 10^6$ N/m
	$M_x, M_y$	10,000 Nm/rad
	$M_z$	20,000 Nm/rad

<sup>1</sup>Expected rating, certification is planned and will be forthcoming (see manual revision date).





## 5.2.2. Overload Capacity

The FT 300 sensors have overload capacities, the overload capacity specification includes load and torque values in all 3 axes.

### Info

For loads between the measuring range and the overload capacity, the signal will be saturated. The sensor will not undergo permanent damage if the overload capacity is not reached.

### Warning

Exceeding the overload capacity will permanently damage the sensor.

Sensor	Measuring range	Overload capacity <sup>1</sup>
FT 300	+/- 300 N	1500 N (500%) <sup>2</sup>

<sup>1</sup>Overload capacity with all axes combined.

<sup>2</sup>Maximum load expressed in % of measuring range.

The overload capacity given includes forces and torques in all 3 axes. To get an approximation of the total load, these formulas must be used:

- For the FT 300

$$F_x/300 + F_y/300 + F_z/300 + M_x/30 + M_y/30 + M_z/30 < 500\%$$



## 5.3. Signal Specifications

SPECIFICATION		FT 300 (prior to 10/2017)	FT 300
Measuring range	Force	$\pm 300$ N	
	Torque	$\pm 30$ Nm	
Signal noise*	Fx, Fy	1.2 N	0.1 N
	Fz	0.5 N	0.1 N
	Mx, My	0.02 Nm	0.005 Nm
	Mz	0.03 Nm	0.003 Nm
Recommended threshold	Fx, Fy	5 N	1 N
	Fz	2 N	1 N
	Mx, My	0.08 Nm	0.02 Nm
	Mz	0.12 Nm	0.01 Nm
External noise sensitivity**		Immune	
Data output rate		100 Hz	
Temperature compensation***		15 to 35 °C	

\*Signal noise is the standard deviation of the signal measured over a period of one (1) second

\*\*Under normal operating conditions

\*\*\*Within this range, the temperature fluctuation is compensated for; signal quality may be affected outside of this range





**Caution**

The recommended threshold represents the smallest variations that can be detected by the sensor.

The signal noise is the limiting factor for the Sensor's precision. For the FT 300, the signal noise defined in the signal specifications is the standard deviation of each data ( $F_x$ ,  $F_y$ ,  $F_z$ ,  $M_x$ ,  $M_y$ ,  $M_z$ ) over 1 second. In order to use that signal noise information, three times the standard deviation given must be used. According to the normal distribution, three times the standard deviation will cover almost all values possible (99.7%).

**Info**

Noise is an unwanted and unpredictable alteration to a signal. It may come from electrical or electromagnetic sources and degrades the quality of the Sensor's signal.



## 5.4. Electrical Ratings

SPECIFICATION	VALUE
Input voltage	5 to 24 V DC $\pm$ 10%
Max power consumption	2 W
Communication electrical interface	RS-485
Recommended fuse	Phoenix #0916604 (UT6-TMC M 1 A)
Recommended power supply	TDK-Lambda DPP Series <i>15W Single Output DIN Rail Mount Power Supply</i> , <b>DPP15-24</b>



## 5.5. Couplings

For a detailed list of available couplings and adapter plates, please refer to the **Spare Parts, Kits and Accessories** section.

The following subsections contain data required for custom couplings or creating couplings from blanks.

### Info

All Robotiq couplings and adapter plates are provided with necessary hardware for fixation on the Robotiq device side.

### Caution

Unless identified for specific packages only, **robot side screws and indexing pins are not provided.**



## 5.5.1. Blank Coupling

The figure below schematics represent the optional blank coupling for the FT 300 Sensor :

- (7) M4 threads and the 63 mm (H8) circle are meant to affix the FT 300.
- The circular section of 75 mm diameter (blue section in the figure below) represents the customization area and has a depth of 5 mm.

### Warning

Make sure your custom design does not interfere with the M4 threads or the 63 mm, H8 centering circle.

- Spare part list number is FTS-300-CPL-BLANK.

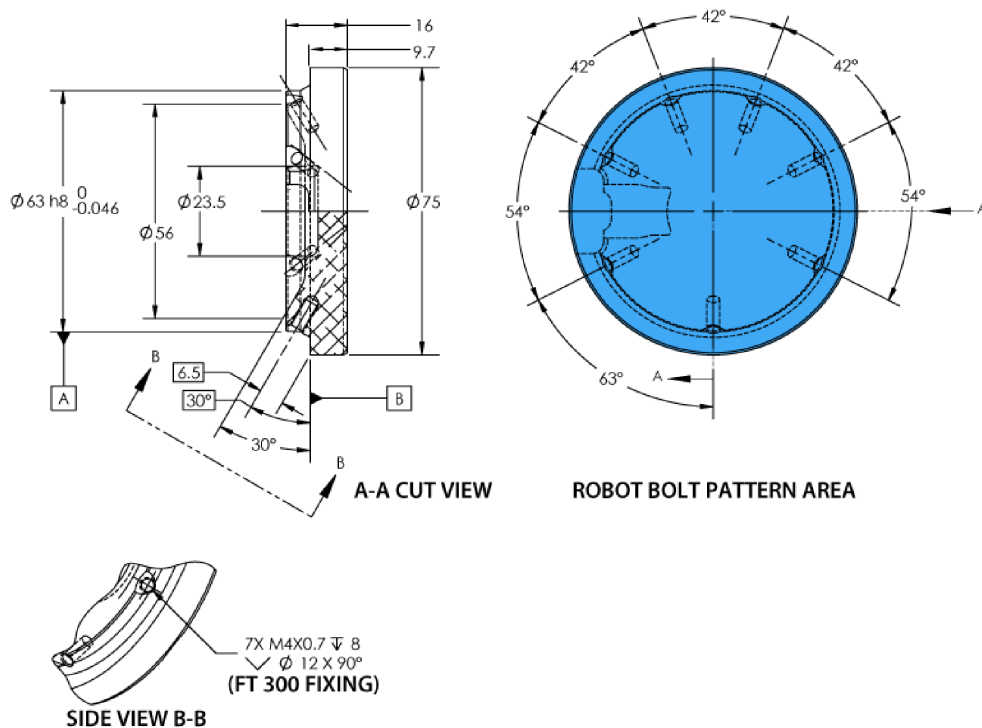

Fig. 5.4: Technical dimensions of the blank coupling for the FT 300.

# 6. Maintenance

The Robotiq Force Torque Sensor requires only external maintenance with limited downtime.

Maintenance of the Sensor is required after specified usage, measured in time (normal 40h week). Respecting the maintenance interval will ensure:

- Correct functioning of your Sensor.
- Validity of your warranty.
- Proper lifetime for your Sensor.

Please visit [support.robotiq.com](https://support.robotiq.com) for details on the maintenance operation.

## Warning

Unless otherwise specified, any repairs done on the FT 300 Force Torque Sensor will be done by Robotiq.

## 6.1. Maintenance Intervals

Operation	Daily	Weekly	Semiannually
Zero calibration	X1		
Sensor cleaning	Dirty conditions	Normal conditions	
Periodic inspection			X2

<sup>1</sup>Zero calibration should be integrated into the program routine. This will compensate for the tool weight (for its current orientation), the effect of the attachment mechanisms on the Sensor and any other factors which could affect the readings. It is recommended to add this instruction when the robot is not applying force on its environment and when the tool is in the same orientation as when the readings will be used (for example at the beginning of the program or just before picking up an object or applying force).

<sup>2</sup>If there is any visible damage to the Sensor, contact [support@robotiq.com](mailto:support@robotiq.com).



# 7. Spare Parts, Kits and Accessories

## Caution

The following list is up to date at print time and is subject to change, check online for updates.

## Info

Unless specified, screws, dowel pins and other hardware are included only for the Sensor side, never for the robot side.

Item	Description	Ordering Number
Standard Kit	Robotiq Force Torque Sensor FT, includes cable and USB converter.	FTS-300-KIT-001
Kit for <i>Universal Robots</i>	Standard Sensor with Couplings for <i>Universal Robots</i> and software package.	FTS-300-UR-KIT
Sensor	Replacement sensor, sensor alone.	FTS-300-SEN-001
Blank coupling	Blank coupling with FT bolt pattern on one side and the other side clear.	FTS-300-CPL-BLANK
Coupling 50-4M6-1D6	Coupling for 50 mm PCD <sup>1</sup> (4) M6 thread and (1) 6 mm M6 indexing pin. To be used on UR robots.	FTS-300-CPL-062
Coupling 39-8M3-1D3	Coupling for 39 mm PCD <sup>1</sup> (8) M3 thread and (1) 3 mm indexing pin.	FTS-300-CPL-069
Coupling 40-4M6-1D6	Coupling for 40 mm PCD <sup>1</sup> (4) M6 thread and (1) 6 mm M6 indexing pin.	FTS-300-CPL-064
Coupling 31_5-4M5-1D5	Coupling for 31.5 mm PCD <sup>1</sup> (4) M5 thread and (1) 5 mm M6 indexing pin.	FTS-300-CPL-063
Robotiq Device Cable	5 or 10 m cable for power and communication with the FT Sensor	CBL-COM-2067-10

<sup>1</sup>Pitch Circle Diameter



---

# 8. Troubleshooting

---

The following are some common troubleshooting hints, if you need further assistance please contact [support@robotiq.com](mailto:support@robotiq.com).

## 8.1. General troubleshooting

### 8.1.1. An offset has appeared in the Sensor data

- Changes in ambient conditions can cause an offset in the sensor signals.
- An offset can also be caused if the sealing o-rings are displaced during an overload.
- These offsets do not account for a de-calibration of the Sensor as they are in fact recognized as effort applied to the Sensor. Any additional force applied on the tool side of the Sensor will be read normally.
- In all cases, it is recommended to have a software offset which compensates for these variations in addition to the effort caused by the tool weight for a given orientation. It is preferable to set the software offset before starting to use the sensor data such that the robot software uses a proper and consistent reference.

### 8.1.2. Procedure to determine if the Sensor is functional

- Verify that the Sensor is connected according to the Installation section of this manual.
- When powered, verify that the LED on the Sensor is blue (not red/blue). FT 300 LED is red if powered without communication, blue if powered with communication. For detailed information on the LED status, refer to the **Status LED** section.
- Power-off the Sensor and then connect the provided USB/RS485 converter to a USB port of a Windows PC.
  - In the Windows PC, open the Device Manager.
  - You should see a USB Serial Port device in the Ports (COM & LPT) category. If not, it is possible that the converter drivers have not installed automatically. You can download the drivers from the [ftdichip.com](http://ftdichip.com) website.
- Power the Sensor with the recommended voltage.
- Download the simple data logger application at [support.robotiq.com](http://support.robotiq.com)
- Run the data logger application. Enter 100 for the number of data per 10 seconds and any file name (for example "test.csv").
- Verify that the sensor data is displayed in the Windows console application.



## 8.2. Troubleshooting on Universal Robots

### 8.2.1. ActiveDrive Toolbar troubleshooting – Error messages overview

The ActiveDrive Toolbar will be automatically collapsed and be greyed whenever one of the following situations occurs. In such cases, by tapping the ActiveDrive button, the following messages will appear:

- Message:

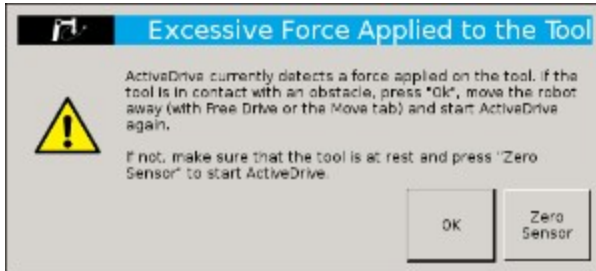

- Solution:

- Starting ActiveDrive while an excessive force is applied to the tool:
  - Determine if an external force is applied to the end-effector. If it is the case, tap **OK** and move the robot away from the obstacle (with Free Drive or Move tab), or remove any external forces and start ActiveDrive again.
  - If no external forces are applied, tap **Zero Sensor**.

- Message:

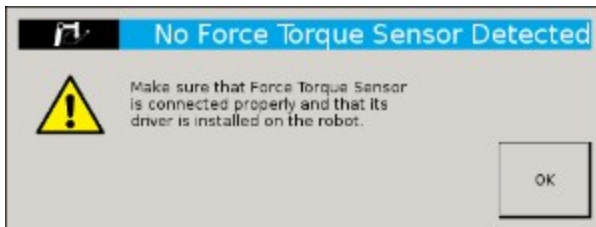

- Solution:

- Force Torque Sensor is detected: Check the Force Torque Sensor's connection. Make sure the USB adapter and all the wires are well connected. Also verify the Sensor's LED status (refer to the **Status LED** section).

- Message:



- Solution:

- The robot is not initialized: Tap **OK** and go to PolyScope's home page. Tap **Setup Robot** and go to **Initialize Robot** to start the robot.





- Message:



- Solution:

- A program is already running: The ActiveDrive Toolbar cannot be used while a program is running. Stop the program to enable the ActiveDrive feature.

- Message:



- Solution:

- The speed setting of the robot is lower than 50%: The robot's speed setting should be greater than 50%. Modify the speed setting in the robot's program with the slider.

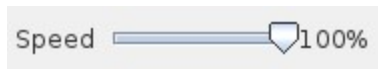

- Message:



- Solution:

- If the Freedrive button is pressed: The ActiveDrive mode cannot be used when the Free Drive mode is on. Make sure you are not pressing on the teach pendant's Teach button when trying to use the ActiveDrive toolbar.

## 8.2.2. Monitoring the Sensor state

In order to view the sensor status and verify the force and torque values:

- Go to **Program Robot**
- Go to the **Installation** tab



- Tap **Force Copilot** in the left pane
- Tap the **Dashboard** button

### Info

If needed, the user can tap the **About** tab to get further information regarding the force torque sensor.

The screenshot displays the 'Force Copilot' application interface. At the top, there are four tabs: 'Dashboard', 'Calibration', 'Configuration', and 'About'. The 'Dashboard' tab is selected. Below the tabs, a green checkmark icon is shown next to the text 'Robotiq Force Torque Sensor is up and running'. Underneath, there are two columns of data: 'Force Values' and 'Moment Values'. The 'Force Values' column shows Fx = 0.2 N, Fy = -0.0 N, and Fz = -0.2 N. The 'Moment Values' column shows Mx = -0.00 Nm, My = 0.00 Nm, and Mz = 0.00 Nm. A blue button labeled 'Zero sensor' is positioned below the data. At the bottom, there is a checked checkbox labeled 'Show ActiveDrive toolbar'.

Force Values		Moment Values	
Fx =	0.2 N	Mx =	-0.00 Nm
Fy =	-0.0 N	My =	0.00 Nm
Fz =	-0.2 N	Mz =	0.00 Nm

## 8.3. Troubleshooting on other platforms

### 8.3.1. USB converter detected as a mouse by Windows

- In Windows, the USB converter is sometimes detected as a mouse, making the cursor move. This is a well known problem in Windows: <http://support.microsoft.com/kb/819036>
- A simple workaround is to plug in the USB converter before powering the Sensor. Once the USB driver is initialized in Windows, the Sensor can be powered and used without a problem.

### 8.3.2. Data frequency under 100 Hz in Windows

- By default, the USB to RS485 converter has a latency setting of 16 ms in Windows (1 ms in Linux), which will prevent the application software from receiving new messages at 100 Hz (it will often read two sensor messages in the buffer at the same time).
- In the Windows Device Manager, right click on the virtual COM port for the Sensor and select **Properties**. In the **Port settings** tab, click on **Advanced**. Adjust the latency timer to **9 ms** (it is not recommended to lower it too much in Windows since other connectivity issues may arise), then click **OK**.

### 8.3.3. In Linux, the serial port cannot be opened

- By default, a user does not have access to the serial ports.
- It is possible to provide this access by adding the user to the dialout group with the following command:

```
rd@debian:~/ $ sudo usermod -a -G dialout username
```





# 9. Warranty

Robotiq warrants the FT 300 Force Torque Sensor against defects in material and workmanship for a period of one year from the date of reception when utilized as intended with the specified maintenance. Robotiq also warrants that this equipment will meet applicable specifications under normal use.

## Caution

Warranty applies under the following conditions:

- Usage respects the operating, transporting and storage conditions specified in the **Environmental and Operating Conditions** section
- Usage under normal one-shift operation (40h a week)
- Usage respects maintenance specified in the **Maintenance** section

During the warranty period, Robotiq will repair or replace any defective product, as well as verify and adjust the product free of charge if the equipment should need to be repaired or if the original adjustment is erroneous. If the equipment is sent back for verification during the warranty period and found to meet all published specifications, Robotiq will charge standard verification fees.

The unit is considered defective when at least one of the following conditions occurs :

- The Sensor feedback is not accessible;
- Sensor signal noise is over twice the specified limit.

## Caution

The warranty will become null and void if the :

- Unit has been tampered with, repaired or worked on by unauthorized individuals.
- Warranty sticker has been removed.
- Screws, other than as explained in this guide, have been removed.
- Unit has been opened.
- Unit serial number has been altered, erased, or removed.
- Unit has been misused, neglected, or damaged by accident.

This warranty is in lieu of all other warranties expressed, implied, or statutory, including, but not limited to, the implied warranties of merchantability and fitness for a particular purpose. In no event shall Robotiq be liable for special, incidental, or consequential damages.

Robotiq shall not be liable for damages resulting from the use of the product, nor shall be responsible for any failure in the performance of other items to which the product is connected or the operation of any system of which the product may be a part.



## 9.1. Exclusions

Robotiq reserves the right to make changes in the design or construction of any of its products at any time without incurring an obligation to make any changes whatsoever on units already purchased.

This warranty excludes failure resulting from: improper use or installation, normal wear and tear, accident, abuse, neglect, fire, water, lightning or other acts of nature, causes external to the product or other factors beyond Robotiq's control.



---

# 10. Contact

---

[www.robotiq.com](http://www.robotiq.com)

## Contact Us

### Phone

1-888-ROBOTIQ (762-6847)

(+1) 418-380-2788 Outside US and Canada

### Fax

1-418-800-0046

### Technical Support

Option 3

### Sales

Option 2

### Head Office

Robotiq  
966, chemin Olivier  
Suite 500  
Lévis, Québec  
G7A 2N1  
Canada



Where automation Pros come to share their know-how and get answers.

[dof.robotiq.com](http://dof.robotiq.com)









## Appendix B – Applied Standards

This section describes all applied harmonized standards for the design and production of the Robotiq Force Torque Sensor FT 300. Standards are applied where applicable, some points may not be applied if not applicable to this specific product. Conformity is not enforced by any laws, it is self-applied and the aim is to define normal safety and performance requirements for similar products.

### Info

Conformity of the product is only met if all instructions of the following manual are followed. Among others; installation, safety measure and normal usage must be respected.

The following standards have been applied:

NF EN ISO 12100	2010	Safety of machinery — General principles for design — Risk assessment and risk reduction
NF EN IEC 60204-1	2006	Safety of machinery — Electrical equipment of machines — Part 1: General requirements

